

# Vibrations and Waves

## Benjamin Crowell



Book 3 in the Light and Matter series of free introductory physics textbooks  
[www.lightandmatter.com](http://www.lightandmatter.com)

You can download this book for free, or buy a printed copy, at [lightandmatter.com](http://lightandmatter.com). It's available under the Creative Commons Attribution-ShareAlike license, [creativecommons.org/licenses/by-sa/1.0](http://creativecommons.org/licenses/by-sa/1.0). (c) 1998-2005 Benjamin Crowell.



# Vibrations and Waves

The **Light and Matter** series of introductory physics textbooks:

- 1 Newtonian Physics
- 2 Conservation Laws
- 3 Vibrations and Waves
- 4 Electricity and Magnetism
- 5 Optics
- 6 The Modern Revolution in Physics

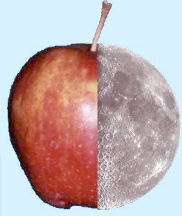

# Vibrations and Waves

Benjamin Crowell

[www.lightandmatter.com](http://www.lightandmatter.com)

 Light and Matter  
Fullerton, California  
[www.lightandmatter.com](http://www.lightandmatter.com)

copyright 1998-2005 Benjamin Crowell

edition 2.2  
rev. 13th October 2006



This book is licensed under the Creative Commons Attribution-ShareAlike license, version 1.0, <http://creativecommons.org/licenses/by-sa/1.0/>, except for those photographs and drawings of which I am not the author, as listed in the photo credits. If you agree to the license, it grants you certain privileges that you would not otherwise have, such as the right to copy the book, or download the digital version free of charge from [www.lightandmatter.com](http://www.lightandmatter.com). At your option, you may also copy this book under the GNU Free Documentation License version 1.2, <http://www.gnu.org/licenses/fdl.txt>, with no invariant sections, no front-cover texts, and no back-cover texts.

ISBN 0-9704670-3-6

To Diz and Bird.





# Brief Contents

- 1 Vibrations 13
- 2 Resonance 25
- 3 Free Waves 47
- 4 Bounded Waves 75

# Contents

## 1 Vibrations

1.1 Period, Frequency, and Amplitude . . . . .	15
1.2 Simple Harmonic Motion . . . . .	17
Why are sine-wave vibrations so common?, 17.—Period is approximately independent of amplitude, if the amplitude is small., 18.	
1.3 ★ Proofs . . . . .	20
Summary . . . . .	22
Problems . . . . .	23



## 2 Resonance

2.1 Energy in Vibrations . . . . .	26
2.2 Energy Lost From Vibrations . . . . .	29
2.3 Putting Energy Into Vibrations . . . . .	31
2.4 ★ Proofs . . . . .	39
Statement 2: maximum amplitude at resonance, 40.—Statement 3: amplitude at resonance proportional to $Q$ , 40.— Statement 4: FWHM related to $Q$ , 40.	
Summary . . . . .	41
Problems . . . . .	43

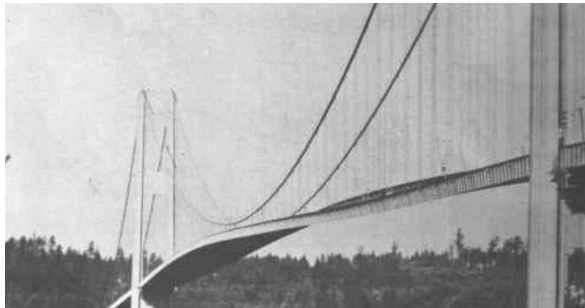

## 3 Free Waves

3.1 Wave Motion . . . . .	49
1. Superposition, 49.—2. The medium is not transported with the wave., 51.—3. A wave's velocity depends on the medium., 52.—Wave patterns, 53.	
3.2 Waves on a String . . . . .	54
Intuitive ideas, 54.—Approximate treatment, 55.—Rigorous derivation using calculus (optional), 56.	
3.3 Sound and Light Waves . . . . .	58
Sound waves, 58.—Light waves, 59	



3.4 Periodic Waves . . . . .	60
Period and frequency of a periodic wave, 60.—Graphs of waves as a function of position, 60.—Wavelength, 61.—Wave ve- locity related to frequency and wavelength, 61.—Sinusoidal waves, 63.	
3.5 The Doppler Effect . . . . .	65
The Big Bang, 67.—What the big bang is not, 68.	
Summary . . . . .	70

Problems . . . . . 72

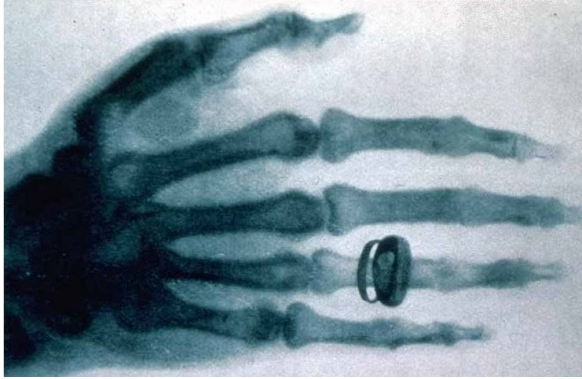

waves, 92.—Standing-wave patterns of air columns, 93.

Summary . . . . . 95  
 Problems . . . . . 96

Appendix 1: Exercises 98  
 Appendix 2: Photo Credits 100  
 Appendix 3: Hints and Solutions 101

## 4 Bounded Waves

4.1 Reflection, Transmission, and Absorption. . . . . 77  
 Reflection and transmission, 77.—  
 Inverted and uninverted reflections, 79.—  
 Absorption, 79.  
 4.2 ★ Quantitative Treatment of Reflection 83  
 Why reflection occurs, 83.—Intensity of reflection, 84.—Inverted and uninverted reflections in general, 85.  
 4.3 Interference Effects . . . . . 87  
 4.4 Waves Bounded on Both Sides . . 89  
 Musical applications, 91.—Standing







The vibrations of this electric bass string are converted to electrical vibrations, then to sound vibrations, and finally to vibrations of our eardrums.

## Chapter 1

# Vibrations

Dandelion. Cello. Read those two words, and your brain instantly conjures a stream of associations, the most prominent of which have to do with vibrations. Our mental category of “dandelion-ness” is strongly linked to the color of light waves that vibrate about half a million billion times a second: yellow. The velvety throb of a cello has as its most obvious characteristic a relatively low musical pitch — the note you are spontaneously imagining right now might be one whose sound vibrations repeat at a rate of a hundred times a second.

Evolution has designed our two most important senses around the assumption that not only will our environment be drenched with information-bearing vibrations, but in addition those vibrations will often be repetitive, so that we can judge colors and pitches by the rate of repetition. Granting that we do sometimes encounter non-repeating waves such as the consonant “sh,” which has no recognizable pitch, why was Nature’s assumption of repetition nevertheless so right in general?

Repeating phenomena occur throughout nature, from the orbits of electrons in atoms to the reappearance of Halley’s Comet every 75 years. Ancient cultures tended to attribute repetitious phenomena

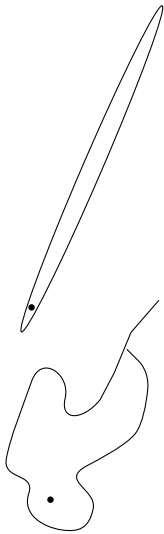

a / If we try to draw a non-repeating orbit for Halley's Comet, it will inevitably end up crossing itself.

like the seasons to the cyclical nature of time itself, but we now have a less mystical explanation. Suppose that instead of Halley's Comet's true, repeating elliptical orbit that closes seamlessly upon itself with each revolution, we decide to take a pen and draw a whimsical alternative path that never repeats. We will not be able to draw for very long without having the path cross itself. But at such a crossing point, the comet has returned to a place it visited once before, and since its potential energy is the same as it was on the last visit, conservation of energy proves that it must again have the same kinetic energy and therefore the same speed. Not only that, but the comet's direction of motion cannot be randomly chosen, because angular momentum must be conserved as well. Although this falls short of being an ironclad proof that the comet's orbit must repeat, it no longer seems surprising that it does.

Conservation laws, then, provide us with a good reason why repetitive motion is so prevalent in the universe. But it goes deeper than that. Up to this point in your study of physics, I have been indoctrinating you with a mechanistic vision of the universe as a giant piece of clockwork. Breaking the clockwork down into smaller and smaller bits, we end up at the atomic level, where the electrons circling the nucleus resemble — well, little clocks! From this point of view, particles of matter are the fundamental building blocks of everything, and vibrations and waves are just a couple of the tricks that groups of particles can do. But at the beginning of the 20th century, the tables were turned. A chain of discoveries initiated by Albert Einstein led to the realization that the so-called subatomic “particles” were in fact waves. In this new world-view, it is vibrations and waves that are fundamental, and the formation of matter is just one of the tricks that waves can do.

## 1.1 Period, Frequency, and Amplitude

Figure b shows our most basic example of a vibration. With no forces on it, the spring assumes its equilibrium length, b/1. It can be stretched, 2, or compressed, 3. We attach the spring to a wall on the left and to a mass on the right. If we now hit the mass with a hammer, 4, it oscillates as shown in the series of snapshots, 4-13. If we assume that the mass slides back and forth without friction and that the motion is one-dimensional, then conservation of energy proves that the motion must be repetitive. When the block comes back to its initial position again, 7, its potential energy is the same again, so it must have the same kinetic energy again. The motion is in the opposite direction, however. Finally, at 10, it returns to its initial position with the same kinetic energy and the same direction of motion. The motion has gone through one complete cycle, and will now repeat forever in the absence of friction.

The usual physics terminology for motion that repeats itself over and over is periodic motion, and the time required for one repetition is called the period,  $T$ . (The symbol  $P$  is not used because of the possible confusion with momentum.) One complete repetition of the motion is called a cycle.

We are used to referring to short-period sound vibrations as “high” in pitch, and it sounds odd to have to say that high pitches have low periods. It is therefore more common to discuss the rapidity of a vibration in terms of the number of vibrations per second, a quantity called the frequency,  $f$ . Since the period is the number of seconds per cycle and the frequency is the number of cycles per second, they are reciprocals of each other,

$$f = 1/T$$

### A carnival game

### example 1

In the carnival game shown in figure c, the rube is supposed to push the bowling ball on the track just hard enough so that it goes over the hump and into the valley, but does not come back out again. If the only types of energy involved are kinetic and potential, this is impossible. Suppose you expect the ball to come back to a point such as the one shown with the dashed outline, then stop and turn around. It would already have passed through this point once before, going to the left on its way into the valley. It was moving then, so conservation of energy tells us that it cannot be at rest when it comes back to the same point. The motion that the customer hopes for is physically impossible. There is a physically possible periodic motion in which the ball rolls back and forth, staying confined within the valley, but there is no way to get the ball into that motion beginning from the place where we start. There is a way to beat the game, though. If you put enough spin on the ball, you can create enough kinetic friction so that a significant amount of heat is generated. Conservation of energy then allows the ball to be at rest when it comes back to a point like the outlined one, because kinetic energy has been converted into heat.

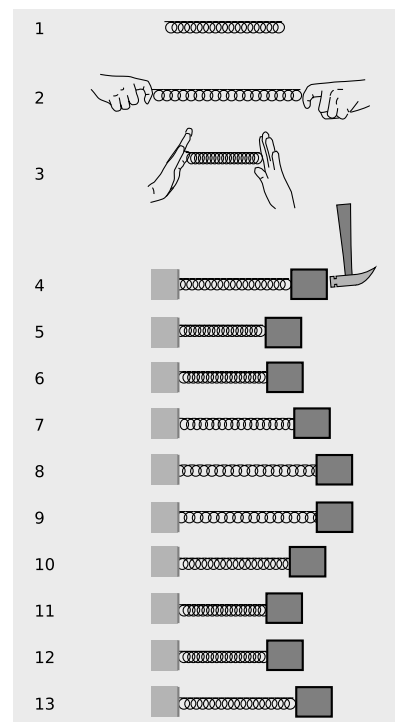

b / A spring has an equilibrium length, 1, and can be stretched, 2, or compressed, 3. A mass attached to the spring can be set into motion initially, 4, and will then vibrate, 4-13.



c / Example 1.

*Period and frequency of a fly's wing-beats*

*example 2*

A Victorian parlor trick was to listen to the pitch of a fly's buzz, reproduce the musical note on the piano, and announce how many times the fly's wings had flapped in one second. If the fly's wings flap, say, 200 times in one second, then the frequency of their motion is  $f = 200/1 \text{ s} = 200 \text{ s}^{-1}$ . The period is one 200th of a second,  $T = 1/f = (1/200) \text{ s} = 0.005 \text{ s}$ .

Units of inverse second,  $\text{s}^{-1}$ , are awkward in speech, so an abbreviation has been created. One Hertz, named in honor of a pioneer of radio technology, is one cycle per second. In abbreviated form,  $1 \text{ Hz} = 1 \text{ s}^{-1}$ . This is the familiar unit used for the frequencies on the radio dial.

*Frequency of a radio station*

*example 3*

▷ KKJZ's frequency is 88.1 MHz. What does this mean, and what period does this correspond to?

▷ The metric prefix M- is mega-, i.e., millions. The radio waves emitted by KKJZ's transmitting antenna vibrate 88.1 million times per second. This corresponds to a period of

$$T = 1/f = 1.14 \times 10^{-8} \text{ s}$$

This example shows a second reason why we normally speak in terms of frequency rather than period: it would be painful to have to refer to such small time intervals routinely. I could abbreviate by telling people that KKJZ's period was 11.4 nanoseconds, but most people are more familiar with the big metric prefixes than with the small ones.

Units of frequency are also commonly used to specify the speeds of computers. The idea is that all the little circuits on a computer chip are synchronized by the very fast ticks of an electronic clock, so that the circuits can all cooperate on a task without getting ahead or behind. Adding two numbers might require, say, 30 clock cycles. Microcomputers these days operate at clock frequencies of about a gigahertz.

We have discussed how to measure how fast something vibrates, but not how big the vibrations are. The general term for this is amplitude,  $A$ . The definition of amplitude depends on the system being discussed, and two people discussing the same system may not even use the same definition. In the example of the block on the end of the spring,  $d/1$ , the amplitude will be measured in distance units such as cm. One could work in terms of the distance traveled by the block from the extreme left to the extreme right, but it would be somewhat more common in physics to use the distance from the center to one extreme. The former is usually referred to as the peak-to-peak amplitude, since the extremes of the motion look like mountain peaks or upside-down mountain peaks on a graph of position versus time.

In other situations we would not even use the same units for amplitude. The amplitude of a child on a swing, or a pendulum,  $d/2$ , would most conveniently be measured as an angle, not a distance,

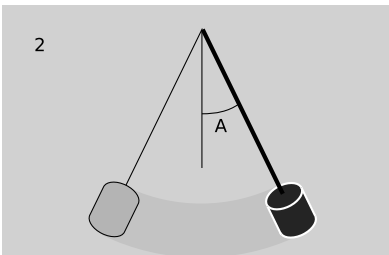
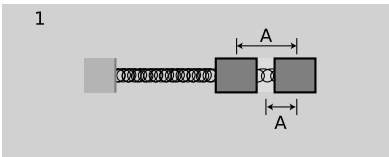

$d/1$ . The amplitude of the vibrations of the mass on a spring could be defined in two different ways. It would have units of distance. 2. The amplitude of a swinging pendulum would more naturally be defined as an angle.



since her feet will move a greater distance than her head. The electrical vibrations in a radio receiver would be measured in electrical units such as volts or amperes.

## 1.2 Simple Harmonic Motion

### Why are sine-wave vibrations so common?

If we actually construct the mass-on-a-spring system discussed in the previous section and measure its motion accurately, we will find that its  $x-t$  graph is nearly a perfect sine-wave shape, as shown in figure e/1. (We call it a “sine wave” or “sinusoidal” even if it is a cosine, or a sine or cosine shifted by some arbitrary horizontal amount.) It may not be surprising that it is a wiggle of this general sort, but why is it a specific mathematically perfect shape? Why is it not a sawtooth shape like 2 or some other shape like 3? The mystery deepens as we find that a vast number of apparently unrelated vibrating systems show the same mathematical feature. A tuning fork, a sapling pulled to one side and released, a car bouncing on its shock absorbers, all these systems will exhibit sine-wave motion under one condition: the amplitude of the motion must be small.

It is not hard to see intuitively why extremes of amplitude would act differently. For example, a car that is bouncing lightly on its shock absorbers may behave smoothly, but if we try to double the amplitude of the vibrations the bottom of the car may begin hitting the ground, e/4. (Although we are assuming for simplicity in this chapter that energy is never dissipated, this is clearly not a very realistic assumption in this example. Each time the car hits the ground it will convert quite a bit of its potential and kinetic energy into heat and sound, so the vibrations would actually die out quite quickly, rather than repeating for many cycles as shown in the figure.)

The key to understanding how an object vibrates is to know how the force on the object depends on the object’s position. If an object is vibrating to the right and left, then it must have a leftward force on it when it is on the right side, and a rightward force when it is on the left side. In one dimension, we can represent the direction of the force using a positive or negative sign, and since the force changes from positive to negative there must be a point in the middle where the force is zero. This is the equilibrium point, where the object would stay at rest if it was released at rest. For convenience of notation throughout this chapter, we will define the origin of our coordinate system so that  $x$  equals zero at equilibrium.

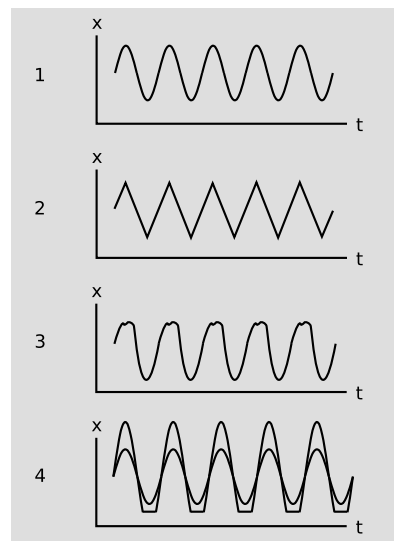

e / Sinusoidal and non-sinusoidal vibrations.

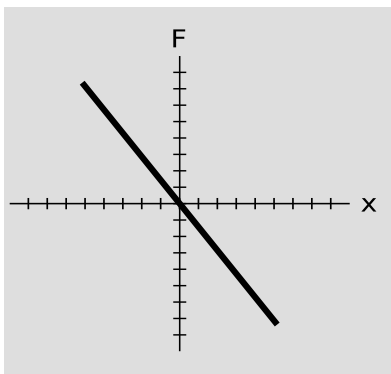

f / The force exerted by an ideal spring, which behaves exactly according to Hooke's law.

The simplest example is the mass on a spring, for which force on the mass is given by Hooke's law,

$$F = -kx$$

We can visualize the behavior of this force using a graph of  $F$  versus  $x$ , as shown in figure f. The graph is a line, and the spring constant,  $k$ , is equal to minus its slope. A stiffer spring has a larger value of  $k$  and a steeper slope. Hooke's law is only an approximation, but it works very well for most springs in real life, as long as the spring isn't compressed or stretched so much that it is permanently bent or damaged.

The following important theorem, whose proof is given in optional section 1.3, relates the motion graph to the force graph.

**Theorem:** A linear force graph makes a sinusoidal motion graph.

If the total force on a vibrating object depends only on the object's position, and is related to the object's displacement from equilibrium by an equation of the form  $F = -kx$ , then the object's motion displays a sinusoidal graph with period  $T = 2\pi\sqrt{m/k}$ .

Even if you do not read the proof, it is not too hard to understand why the equation for the period makes sense. A greater mass causes a greater period, since the force will not be able to whip a massive object back and forth very rapidly. A larger value of  $k$  causes a shorter period, because a stronger force can whip the object back and forth more rapidly.

This may seem like only an obscure theorem about the mass-on-a-spring system, but figure g shows it to be far more general than that. Figure g/1 depicts a force curve that is not a straight line. A system with this  $F - x$  curve would have large-amplitude vibrations that were complex and not sinusoidal. But the same system would exhibit sinusoidal small-amplitude vibrations. This is because any curve looks linear from very close up. If we magnify the  $F - x$  graph as shown in figure g/2, it becomes very difficult to tell that the graph is not a straight line. If the vibrations were confined to the region shown in g/2, they would be very nearly sinusoidal. This is the reason why sinusoidal vibrations are a universal feature of all vibrating systems, if we restrict ourselves to small amplitudes. The theorem is therefore of great general significance. It applies throughout the universe, to objects ranging from vibrating stars to vibrating nuclei. A sinusoidal vibration is known as simple harmonic motion.

**Period is approximately independent of amplitude, if the amplitude is small.**

Until now we have not even mentioned the most counterintuitive aspect of the equation  $T = 2\pi\sqrt{m/k}$ : it does not depend on

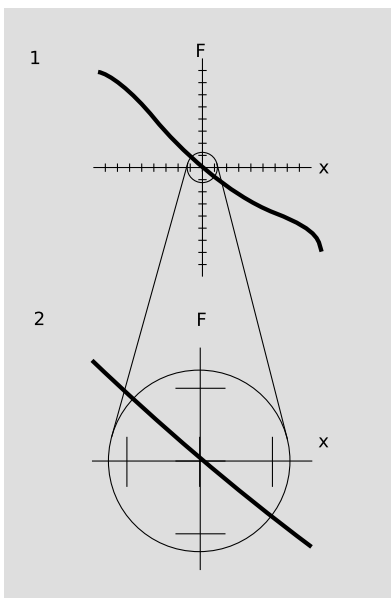

g / Seen from close up, any  $F - x$  curve looks like a line.

amplitude at all. Intuitively, most people would expect the mass-on-a-spring system to take longer to complete a cycle if the amplitude was larger. (We are comparing amplitudes that are different from each other, but both small enough that the theorem applies.) In fact the larger-amplitude vibrations take the same amount of time as the small-amplitude ones. This is because at large amplitudes, the force is greater, and therefore accelerates the object to higher speeds.

Legend has it that this fact was first noticed by Galileo during what was apparently a less than enthralling church service. A gust of wind would now and then start one of the chandeliers in the cathedral swaying back and forth, and he noticed that regardless of the amplitude of the vibrations, the period of oscillation seemed to be the same. Up until that time, he had been carrying out his physics experiments with such crude time-measuring techniques as feeling his own pulse or singing a tune to keep a musical beat. But after going home and testing a pendulum, he convinced himself that he had found a superior method of measuring time. Even without a fancy system of pulleys to keep the pendulum's vibrations from dying down, he could get very accurate time measurements, because the gradual decrease in amplitude due to friction would have no effect on the pendulum's period. (Galileo never produced a modern-style pendulum clock with pulleys, a minute hand, and a second hand, but within a generation the device had taken on the form that persisted for hundreds of years after.)

---

*The pendulum*

*example 4*

- ▷ Compare the periods of pendula having bobs with different masses.
- ▷ From the equation  $T = 2\pi\sqrt{m/k}$ , we might expect that a larger mass would lead to a longer period. However, increasing the mass also increases the forces that act on the pendulum: gravity and the tension in the string. This increases  $k$  as well as  $m$ , so the period of a pendulum is independent of  $m$ .

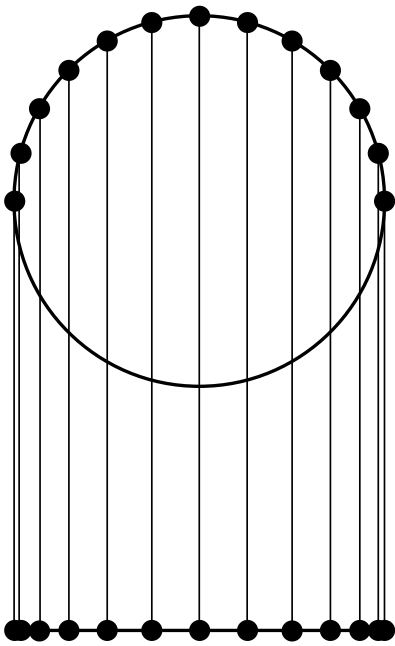

The object moves along the circle at constant speed, but even though its overall speed is constant, the  $x$  and  $y$  components of its velocity are continuously changing, as shown by the unequal spacing of the points when projected onto the line below. Projected onto the line, its motion is the same as that of an object experiencing a force  $F = -kx$ .

### 1.3 ★ Proofs

In this section we prove (1) that a linear  $F - x$  graph gives sinusoidal motion, (2) that the period of the motion is  $2\pi\sqrt{m/k}$ , and (3) that the period is independent of the amplitude. You may omit this section without losing the continuity of the chapter.

The basic idea of the proof can be understood by imagining that you are watching a child on a merry-go-round from far away. Because you are in the same horizontal plane as her motion, she appears to be moving from side to side along a line. Circular motion viewed edge-on doesn't just look like any kind of back-and-forth motion, it looks like motion with a sinusoidal  $x-t$  graph, because the sine and cosine functions can be defined as the  $x$  and  $y$  coordinates of a point at angle  $\theta$  on the unit circle. The idea of the proof, then, is to show that an object acted on by a force that varies as  $F = -kx$  has motion that is identical to circular motion projected down to one dimension. The equation will also fall out nicely at the end.

For an object performing uniform circular motion, we have

$$|\mathbf{a}| = \frac{v^2}{r} .$$

The  $x$  component of the acceleration is therefore

$$a_x = \frac{v^2}{r} \cos \theta ,$$

where  $\theta$  is the angle measured counterclockwise from the  $x$  axis. Applying Newton's second law,

$$\frac{F_x}{m} = -\frac{v^2}{r} \cos \theta , \quad \text{so}$$

$$F_x = -m \frac{v^2}{r} \cos \theta .$$

Since our goal is an equation involving the period, it is natural to eliminate the variable  $v = \text{circumference}/T = 2\pi r/T$ , giving

$$F_x = -\frac{4\pi^2 m r}{T^2} \cos \theta .$$

The quantity  $r \cos \theta$  is the same as  $x$ , so we have

$$F_x = -\frac{4\pi^2 m}{T^2} x .$$

Since everything is constant in this equation except for  $x$ , we have proved that motion with force proportional to  $x$  is the same as circular motion projected onto a line, and therefore that a force proportional to  $x$  gives sinusoidal motion. Finally, we identify the constant factor of  $4\pi^2 m/T^2$  with  $k$ , and solving for  $T$  gives the desired equation for the period,

$$T = 2\pi \sqrt{\frac{m}{k}} .$$

Since this equation is independent of  $r$ ,  $T$  is independent of the amplitude, subject to the initial assumption of perfect  $F = -kx$  behavior, which in reality will only hold approximately for small  $x$ .

*The moons of Jupiter.*

*example 5*

The idea behind this proof is aptly illustrated by the moons of Jupiter. Their discovery by Galileo was an epochal event in astronomy, because it proved that not everything in the universe had to revolve around the earth as had been believed. Galileo's telescope was of poor quality by modern standards, but figure i shows a simulation of how Jupiter and its moons might appear at intervals of three hours through a large present-day instrument. Because we see the moons' circular orbits edge-on, they appear to perform sinusoidal vibrations. Over this time period, the innermost moon, Io, completes half a cycle.

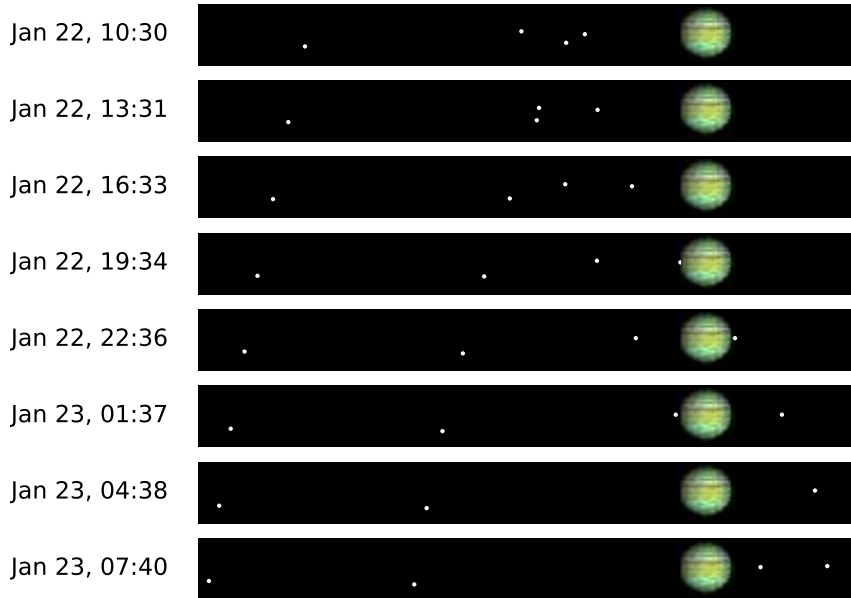

i / Example 5.

## Summary

### Selected Vocabulary

periodic motion . . . . .	motion that repeats itself over and over
period . . . . .	the time required for one cycle of a periodic motion
frequency . . . . .	the number of cycles per second, the inverse of the period
amplitude . . . . .	the amount of vibration, often measured from the center to one side; may have different units depending on the nature of the vibration
simple harmonic motion . . . . .	motion whose $x - t$ graph is a sine wave

### Notation

$T$ . . . . .	period
$f$ . . . . .	frequency
$A$ . . . . .	amplitude
$k$ . . . . .	the slope of the graph of $F$ versus $x$ , where $F$ is the total force acting on an object and $x$ is the object's position; For a spring, this is known as the spring constant.

### Other Terminology and Notation

$\nu$ . . . . .	The Greek letter $\nu$ , nu, is used in many books for frequency.
$\omega$ . . . . .	The Greek letter $\omega$ , omega, is often used as an abbreviation for $2\pi f$ .

## Summary

Periodic motion is common in the world around us because of conservation laws. An important example is one-dimensional motion in which the only two forms of energy involved are potential and kinetic; in such a situation, conservation of energy requires that an object repeat its motion, because otherwise when it came back to the same point, it would have to have a different kinetic energy and therefore a different total energy.

Not only are periodic vibrations very common, but small-amplitude vibrations are always sinusoidal as well. That is, the  $x - t$  graph is a sine wave. This is because the graph of force versus position will always look like a straight line on a sufficiently small scale. This type of vibration is called simple harmonic motion. In simple harmonic motion, the period is independent of the amplitude, and is given by

$$T = 2\pi\sqrt{m/k} \quad .$$

## Problems

### Key

- ✓ A computerized answer check is available online.
- ∫ A problem that requires calculus.
- ★ A difficult problem.

**1** Find an equation for the frequency of simple harmonic motion in terms of  $k$  and  $m$ .

**2** Many single-celled organisms propel themselves through water with long tails, which they wiggle back and forth. (The most obvious example is the sperm cell.) The frequency of the tail's vibration is typically about 10-15 Hz. To what range of periods does this range of frequencies correspond?

**3** (a) Pendulum 2 has a string twice as long as pendulum 1. If we define  $x$  as the distance traveled by the bob along a circle away from the bottom, how does the  $k$  of pendulum 2 compare with the  $k$  of pendulum 1? Give a numerical ratio. [Hint: the total force on the bob is the same if the angles away from the bottom are the same, but equal angles do not correspond to equal values of  $x$ .]

(b) Based on your answer from part (a), how does the period of pendulum 2 compare with the period of pendulum 1? Give a numerical ratio.

**4** A pneumatic spring consists of a piston riding on top of the air in a cylinder. The upward force of the air on the piston is given by  $F_{air} = ax^{-1.4}$ , where  $a$  is a constant with funny units of  $\text{N}\cdot\text{m}^{1.4}$ . For simplicity, assume the air only supports the weight,  $F_W$ , of the piston itself, although in practice this device is used to support some other object. The equilibrium position,  $x_0$ , is where  $F_W$  equals  $-F_{air}$ . (Note that in the main text I have assumed the equilibrium position to be at  $x = 0$ , but that is not the natural choice here.) Assume friction is negligible, and consider a case where the amplitude of the vibrations is very small. Let  $a = 1 \text{ N}\cdot\text{m}^{1.4}$ ,  $x_0 = 1.00 \text{ m}$ , and  $F_W = -1.00 \text{ N}$ . The piston is released from  $x = 1.01 \text{ m}$ . Draw a neat, accurate graph of the total force,  $F$ , as a function of  $x$ , on graph paper, covering the range from  $x = 0.98 \text{ m}$  to  $1.02 \text{ m}$ . Over this small range, you will find that the force is very nearly proportional to  $x - x_0$ . Approximate the curve with a straight line, find its slope, and derive the approximate period of oscillation. ✓

**5** Consider the same pneumatic piston described in problem 4, but now imagine that the oscillations are not small. Sketch a graph of the total force on the piston as it would appear over this wider range of motion. For a wider range of motion, explain why the vibration of the piston about equilibrium is not simple harmonic motion, and sketch a graph of  $x$  vs  $t$ , showing roughly how the curve is different from a sine wave. [Hint: Acceleration corresponds

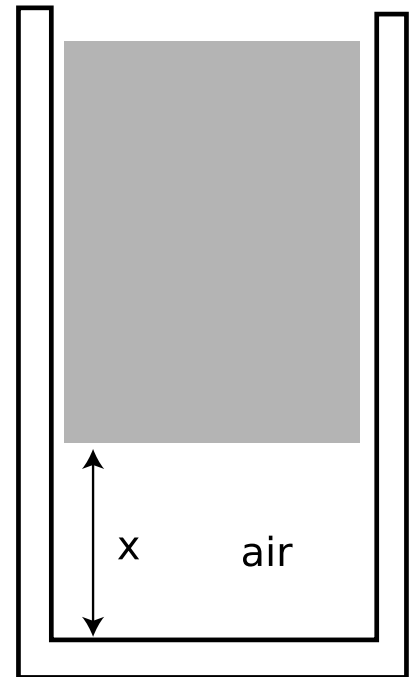

Problem 4.

to the curvature of the  $x - t$  graph, so if the force is greater, the graph should curve around more quickly.]

**6** Archimedes' principle states that an object partly or wholly immersed in fluid experiences a buoyant force equal to the weight of the fluid it displaces. For instance, if a boat is floating in water, the upward pressure of the water (vector sum of all the forces of the water pressing inward and upward on every square inch of its hull) must be equal to the weight of the water displaced, because if the boat was instantly removed and the hole in the water filled back in, the force of the surrounding water would be just the right amount to hold up this new "chunk" of water. (a) Show that a cube of mass  $m$  with edges of length  $b$  floating upright (not tilted) in a fluid of density  $\rho$  will have a draft (depth to which it sinks below the waterline)  $h$  given at equilibrium by  $h_0 = m/b^2\rho$ . (b) Find the total force on the cube when its draft is  $h$ , and verify that plugging in  $h - h_0$  gives a total force of zero. (c) Find the cube's period of oscillation as it bobs up and down in the water, and show that can be expressed in terms of and  $g$  only.

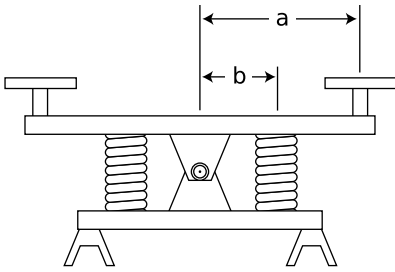

Problem 7.

**7** The figure shows a see-saw with two springs at Codornices Park in Berkeley, California. Each spring has spring constant  $k$ , and a kid of mass  $m$  sits on each seat. (a) Find the period of vibration in terms of the variables  $k$ ,  $m$ ,  $a$ , and  $b$ . (b) Discuss the special case where  $a = b$ , rather than  $a > b$  as in the real see-saw. (c) Show that your answer to part a also makes sense in the case of  $b = 0$ . ★

**8** Show that the equation  $T = 2\pi\sqrt{m/k}$  has units that make sense.

**9** A hot scientific question of the 18th century was the shape of the earth: whether its radius was greater at the equator than at the poles, or the other way around. One method used to attack this question was to measure gravity accurately in different locations on the earth using pendula. If the highest and lowest latitudes accessible to explorers were 0 and 70 degrees, then the the strength of gravity would in reality be observed to vary over a range from about 9.780 to 9.826  $\text{m/s}^2$ . This change, amounting to 0.046  $\text{m/s}^2$ , is greater than the 0.022  $\text{m/s}^2$  effect to be expected if the earth had been spherical. The greater effect occurs because the equator feels a reduction due not just to the acceleration of the spinning earth out from under it, but also to the greater radius of the earth at the equator. What is the accuracy with which the period of a one-second pendulum would have to be measured in order to prove that the earth was not a sphere, and that it bulged at the equator?



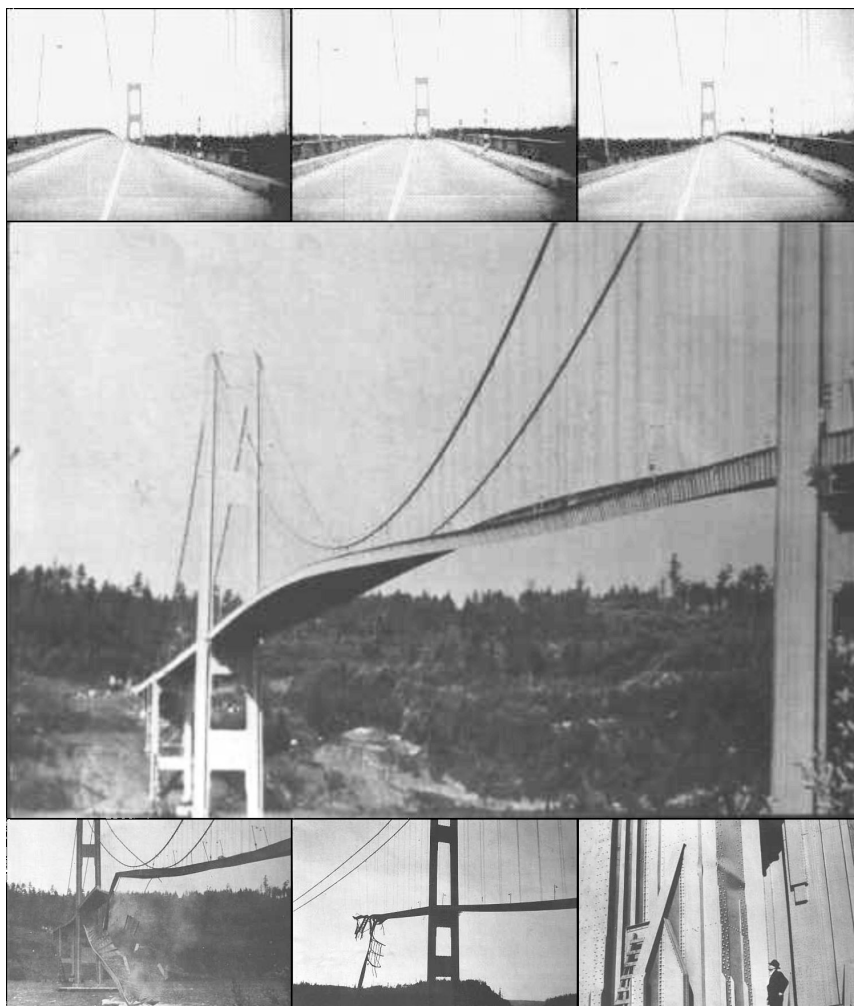

*Top:* A series of images from a film of the Tacoma Narrows Bridge vibrating on the day it was to collapse. *Middle:* The bridge immediately before the collapse, with the sides vibrating 8.5 meters (28 feet) up and down. Note that the bridge is over a mile long. *Bottom:* During and after the final collapse. The right-hand picture gives a sense of the massive scale of the construction.

## Chapter 2

# Resonance

Soon after the mile-long Tacoma Narrows Bridge opened in July 1940, motorists began to notice its tendency to vibrate frighteningly in even a moderate wind. Nicknamed “Gallop-ing Gertie,” the bridge collapsed in a steady 42-mile-per-hour wind on November 7 of the same year. The following is an eyewitness report from a newspaper editor who found himself on the bridge as the vibrations approached the breaking point.

“Just as I drove past the towers, the bridge began to sway violently from side to side. Before I realized it, the tilt became so violent that I lost control of the car... I jammed on the brakes and

got out, only to be thrown onto my face against the curb.

“Around me I could hear concrete cracking. I started to get my dog Tubby, but was thrown again before I could reach the car. The car itself began to slide from side to side of the roadway.

“On hands and knees most of the time, I crawled 500 yards or more to the towers... My breath was coming in gasps; my knees were raw and bleeding, my hands bruised and swollen from gripping the concrete curb... Toward the last, I risked rising to my feet and running a few yards at a time... Safely back at the toll plaza, I saw the bridge in its final collapse and saw my car plunge into the Narrows.”

The ruins of the bridge formed an artificial reef, one of the world’s largest. It was not replaced for ten years. The reason for its collapse was not substandard materials or construction, nor was the bridge under-designed: the piers were hundred-foot blocks of concrete, the girders massive and made of carbon steel. The bridge was destroyed because of the physical phenomenon of resonance, the same effect that allows an opera singer to break a wine glass with her voice and that lets you tune in the radio station you want. The replacement bridge, which has lasted half a century so far, was built smarter, not stronger. The engineers learned their lesson and simply included some slight modifications to avoid the resonance phenomenon that spelled the doom of the first one.

## 2.1 Energy in Vibrations

One way of describing the collapse of the bridge is that the bridge kept taking energy from the steadily blowing wind and building up more and more energetic vibrations. In this section, we discuss the energy contained in a vibration, and in the subsequent sections we will move on to the loss of energy and the adding of energy to a vibrating system, all with the goal of understanding the important phenomenon of resonance.

Going back to our standard example of a mass on a spring, we find that there are two forms of energy involved: the potential energy stored in the spring and the kinetic energy of the moving mass. We may start the system in motion either by hitting the mass to put in kinetic energy by pulling it to one side to put in potential energy. Either way, the subsequent behavior of the system is identical. It trades energy back and forth between kinetic and potential energy. (We are still assuming there is no friction, so that no energy is converted to heat, and the system never runs down.)

The most important thing to understand about the energy content of vibrations is that the total energy is proportional to the

square of the amplitude. Although the total energy is constant, it is instructive to consider two specific moments in the motion of the mass on a spring as examples. When the mass is all the way to one side, at rest and ready to reverse directions, all its energy is potential. We have already seen that the potential energy stored in a spring equals  $(1/2)kx^2$ , so the energy is proportional to the square of the amplitude. Now consider the moment when the mass is passing through the equilibrium point at  $x = 0$ . At this point it has no potential energy, but it does have kinetic energy. The velocity is proportional to the amplitude of the motion, and the kinetic energy,  $(1/2)mv^2$ , is proportional to the square of the velocity, so again we find that the energy is proportional to the square of the amplitude. The reason for singling out these two points is merely instructive; proving that energy is proportional to  $A^2$  at any point would suffice to prove that energy is proportional to  $A^2$  in general, since the energy is constant.

Are these conclusions restricted to the mass-on-a-spring example? No. We have already seen that  $F = -kx$  is a valid approximation for any vibrating object, as long as the amplitude is small. We are thus left with a very general conclusion: the energy of any vibration is approximately proportional to the square of the amplitude, provided that the amplitude is small.

*Water in a U-tube*

*example 1*

If water is poured into a U-shaped tube as shown in the figure, it can undergo vibrations about equilibrium. The energy of such a vibration is most easily calculated by considering the “turnaround point” when the water has stopped and is about to reverse directions. At this point, it has only potential energy and no kinetic energy, so by calculating its potential energy we can find the energy of the vibration. This potential energy is the same as the work that would have to be done to take the water out of the right-hand side down to a depth  $A$  below the equilibrium level, raise it through a height  $A$ , and place it in the left-hand side. The weight of this chunk of water is proportional to  $A$ , and so is the height through which it must be lifted, so the energy is proportional to  $A^2$ .

*The range of energies of sound waves*

*example 2*

▷ The amplitude of vibration of your eardrum at the threshold of pain is about  $10^6$  times greater than the amplitude with which it vibrates in response to the softest sound you can hear. How many times greater is the energy with which your ear has to cope for the painfully loud sound, compared to the soft sound?

▷ The amplitude is  $10^6$  times greater, and energy is proportional to the square of the amplitude, so the energy is greater by a factor of  $10^{12}$ . This is a phenomenally large factor!

We are only studying vibrations right now, not waves, so we are not yet concerned with how a sound wave works, or how the energy gets to us through the air. Note that because of the huge range of

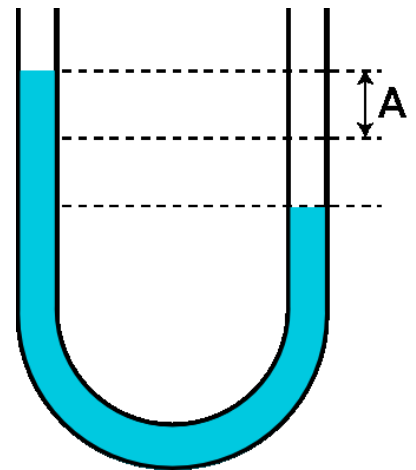

a / Example 1.

energies that our ear can sense, it would not be reasonable to have a sense of loudness that was additive. Consider, for instance, the following three levels of sound:

barely audible wind	
quiet conversation . . . .	$10^5$ times more energy than the wind
heavy metal concert ..	$10^{12}$ times more energy than the wind

In terms of addition and subtraction, the difference between the wind and the quiet conversation is nothing compared to the difference between the quiet conversation and the heavy metal concert. Evolution wanted our sense of hearing to be able to encompass all these sounds without collapsing the bottom of the scale so that anything softer than the crack of doom would sound the same. So rather than making our sense of loudness additive, mother nature made it multiplicative. We sense the difference between the wind and the quiet conversation as spanning a range of about 5/12 as much as the whole range from the wind to the heavy metal concert. Although a detailed discussion of the decibel scale is not relevant here, the basic point to note about the decibel scale is that it is logarithmic. The zero of the decibel scale is close to the lower limit of human hearing, and adding 1 unit to the decibel measurement corresponds to *multiplying* the energy level (or actually the power per unit area) by a certain factor.

## 2.2 Energy Lost From Vibrations

Until now, we have been making the relatively unrealistic assumption that a vibration would never die out. For a realistic mass on a spring, there will be friction, and the kinetic and potential energy of the vibrations will therefore be gradually converted into heat. Similarly, a guitar string will slowly convert its kinetic and potential energy into sound. In all cases, the effect is to “pinch” the sinusoidal  $x - t$  graph more and more with passing time. Friction is not necessarily bad in this context — a musical instrument that never got rid of any of its energy would be completely silent! The dissipation of the energy in a vibration is known as damping.

### *self-check A*

Most people who try to draw graphs like those shown on the left will tend to shrink their wiggles horizontally as well as vertically. Why is this wrong? ▷ Answer, p. 101

In the graphs in figure b, I have not shown any point at which the damped vibration finally stops completely. Is this realistic? Yes and no. If energy is being lost due to friction between two solid surfaces, then we expect the force of friction to be nearly independent of velocity. This constant friction force puts an upper limit on the total distance that the vibrating object can ever travel without replenishing its energy, since work equals force times distance, and the object must stop doing work when its energy is all converted into heat. (The friction force does reverse directions when the object turns around, but reversing the direction of the motion at the same time that we reverse the direction of the force makes it certain that the object is always doing positive work, not negative work.)

Damping due to a constant friction force is not the only possibility however, or even the most common one. A pendulum may be damped mainly by air friction, which is approximately proportional to  $v^2$ , while other systems may exhibit friction forces that are proportional to  $v$ . It turns out that friction proportional to  $v$  is the simplest case to analyze mathematically, and anyhow all the important physical insights can be gained by studying this case.

If the friction force is proportional to  $v$ , then as the vibrations die down, the frictional forces get weaker due to the lower speeds. The less energy is left in the system, the more miserly the system becomes with giving away any more energy. Under these conditions, the vibrations theoretically never die out completely, and mathematically, the loss of energy from the system is exponential: the system loses a fixed percentage of its energy per cycle. This is referred to as exponential decay.

A non-rigorous proof is as follows. The force of friction is proportional to  $v$ , and  $v$  is proportional to how far the objects travels in one cycle, so the frictional force is proportional to amplitude. The

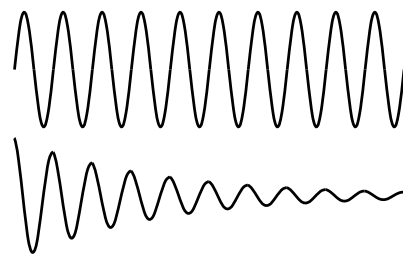

b / Friction has the effect of pinching the  $x - t$  graph of a vibrating object.

amount of work done by friction is proportional to the force and to the distance traveled, so the work done in one cycle is proportional to the square of the amplitude. Since both the work and the energy are proportional to  $A^2$ , the amount of energy taken away by friction in one cycle is a fixed percentage of the amount of energy the system has.

*self-check B*

Figure c shows an  $x$ - $t$  graph for a strongly damped vibration, which loses half of its amplitude with every cycle. What fraction of the energy is lost in each cycle? ▷ Answer, p. 101

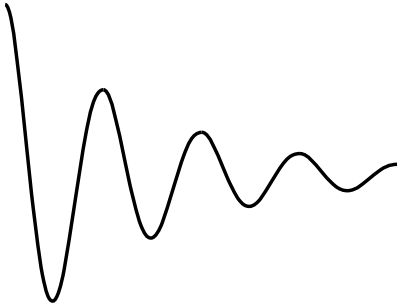

c / The amplitude is halved with each cycle.

It is customary to describe the amount of damping with a quantity called the quality factor,  $Q$ , defined as the number of cycles required for the energy to fall off by a factor of 535. (The origin of this obscure numerical factor is  $e^{2\pi}$ , where  $e = 2.71828\dots$  is the base of natural logarithms. Choosing this particular number causes some of our later equations to come out nice and simple.) The terminology arises from the fact that friction is often considered a bad thing, so a mechanical device that can vibrate for many oscillations before it loses a significant fraction of its energy would be considered a high-quality device.

*Exponential decay in a trumpet*

*example 3*

▷ The vibrations of the air column inside a trumpet have a  $Q$  of about 10. This means that even after the trumpet player stops blowing, the note will keep sounding for a short time. If the player suddenly stops blowing, how will the sound intensity 20 cycles later compare with the sound intensity while she was still blowing?

▷ The trumpet's  $Q$  is 10, so after 10 cycles the energy will have fallen off by a factor of 535. After another 10 cycles we lose another factor of 535, so the sound intensity is reduced by a factor of  $535 \times 535 = 2.9 \times 10^5$ .

The decay of a musical sound is part of what gives it its character, and a good musical instrument should have the right  $Q$ , but the  $Q$  that is considered desirable is different for different instruments. A guitar is meant to keep on sounding for a long time after a string has been plucked, and might have a  $Q$  of 1000 or 10000. One of the reasons why a cheap synthesizer sounds so bad is that the sound suddenly cuts off after a key is released.

*Q of a stereo speaker*

*example 4*

Stereo speakers are not supposed to reverberate or “ring” after an electrical signal that stops suddenly. After all, the recorded music was made by musicians who knew how to shape the decays of their notes correctly. Adding a longer “tail” on every note would make it sound wrong. We therefore expect that stereo speaker will have a very low  $Q$ , and indeed, most speakers are designed with a  $Q$  of about 1. (Low-quality speakers with larger  $Q$  values are referred to as “boomy.”)

We will see later in the chapter that there are other reasons why a speaker should not have a high  $Q$ .

## 2.3 Putting Energy Into Vibrations

When pushing a child on a swing, you cannot just apply a constant force. A constant force will move the swing out to a certain angle, but will not allow the swing to start swinging. Nor can you give short pushes at randomly chosen times. That type of random pushing would increase the child's kinetic energy whenever you happened to be pushing in the same direction as her motion, but it would reduce her energy when your pushing happened to be in the opposite direction compared to her motion. To make her build up her energy, you need to make your pushes rhythmic, pushing at the same point in each cycle. In other words, your force needs to form a repeating pattern with the same frequency as the normal frequency of vibration of the swing. Graph d/1 shows what the child's  $x - t$  graph would look like as you gradually put more and more energy into her vibrations. A graph of your *force* versus time would probably look something like graph 2. It turns out, however, that it is much simpler mathematically to consider a vibration with energy being pumped into it by a driving force that is itself a sine-wave, 3. A good example of this is your eardrum being driven by the force of a sound wave.

Now we know realistically that the child on the swing will not keep increasing her energy forever, nor does your eardrum end up exploding because a continuing sound wave keeps pumping more and more energy into it. In any realistic system, there is energy going out as well as in. As the vibrations increase in amplitude, there is an increase in the amount of energy taken away by damping with each cycle. This occurs for two reasons. Work equals force times distance (or, more accurately, the area under the force-distance curve). As the amplitude of the vibrations increases, the damping force is being applied over a longer distance. Furthermore, the damping force usually increases with velocity (we usually assume for simplicity that it is proportional to velocity), and this also serves to increase the rate at which damping forces remove energy as the amplitude increases. Eventually (and small children and our eardrums are thankful for this!), the amplitude approaches a maximum value, e, at which energy is removed by the damping force just as quickly as it is being put in by the driving force.

This process of approaching a maximum amplitude happens extremely quickly in many cases, e.g., the ear or a radio receiver, and we don't even notice that it took a millisecond or a microsecond for the vibrations to "build up steam." We are therefore mainly interested in predicting the behavior of the system once it has had enough time to reach essentially its maximum amplitude. This is known as the steady-state behavior of a vibrating system.

Now comes the interesting part: what happens if the frequency of the driving force is mismatched to the frequency at which the system would naturally vibrate on its own? We all know that a

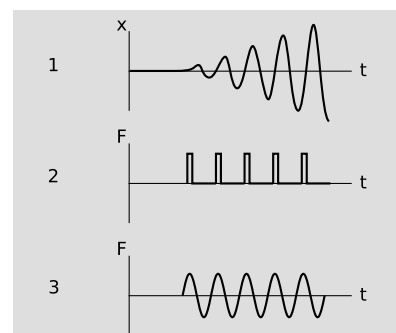

- d / 1. Pushing a child on a swing gradually puts more and more energy into her vibrations.  
2. A fairly realistic graph of the driving force acting on the child.  
3. A less realistic, but more mathematically simple, driving force.

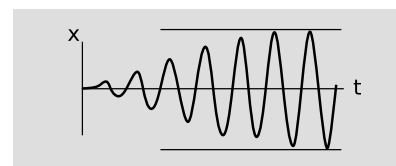

- e / The amplitude approaches a maximum.

radio station doesn't have to be tuned in exactly, although there is only a small range over which a given station can be received. The designers of the radio had to make the range fairly small to make it possible eliminate unwanted stations that happened to be nearby in frequency, but it couldn't be too small or you wouldn't be able to adjust the knob accurately enough. (Even a digital radio can be tuned to 88.0 MHz and still bring in a station at 88.1 MHz.) The ear also has some natural frequency of vibration, but in this case the range of frequencies to which it can respond is quite broad. Evolution has made the ear's frequency response as broad as possible because it was to our ancestors' advantage to be able to hear everything from a low roars to a high-pitched shriek.

The remainder of this section develops four important facts about the response of a system to a driving force whose frequency is not necessarily the same as the system's natural frequency of vibration. The style is approximate and intuitive, but proofs are given in the subsequent optional section.

First, although we know the ear has a frequency — about 4000 Hz — at which it would vibrate naturally, it does not vibrate at 4000 Hz in response to a low-pitched 200 Hz tone. It always responds at the frequency at which it is driven. Otherwise all pitches would sound like 4000 Hz to us. This is a general fact about driven vibrations:

(1) The steady-state response to a sinusoidal driving force occurs at the frequency of the force, not at the system's own natural frequency of vibration.

Now let's think about the amplitude of the steady-state response. Imagine that a child on a swing has a natural frequency of vibration of 1 Hz, but we are going to try to make her swing back and forth at 3 Hz. We intuitively realize that quite a large force would be needed to achieve an amplitude of even 30 cm, i.e., the amplitude is less in proportion to the force. When we push at the natural frequency of 1 Hz, we are essentially just pumping energy back into the system to compensate for the loss of energy due to the damping (friction) force. At 3 Hz, however, we are not just counteracting friction. We are also providing an extra force to make the child's momentum reverse itself more rapidly than it would if gravity and the tension in the chain were the only forces acting. It is as if we are artificially increasing the  $k$  of the swing, but this is wasted effort because we spend just as much time decelerating the child (taking energy out of the system) as accelerating her (putting energy in).

Now imagine the case in which we drive the child at a very low frequency, say 0.02 Hz or about one vibration per minute. We are essentially just holding the child in position while very slowly walking back and forth. Again we intuitively recognize that the



amplitude will be very small in proportion to our driving force. Imagine how hard it would be to hold the child at our own head-level when she is at the end of her swing! As in the too-fast 3 Hz case, we are spending most of our effort in artificially changing the  $k$  of the swing, but now rather than reinforcing the gravity and tension forces we are working against them, effectively reducing  $k$ . Only a very small part of our force goes into counteracting friction, and the rest is used in repetitively putting potential energy in on the upswing and taking it back out on the downswing, without any long-term gain.

We can now generalize to make the following statement, which is true for all driven vibrations:

(2) A vibrating system resonates at its own natural frequency. That is, the amplitude of the steady-state response is greatest in proportion to the amount of driving force when the driving force matches the natural frequency of vibration.

*An opera singer breaking a wine glass* *example 5*  
In order to break a wineglass by singing, an opera singer must first tap the glass to find its natural frequency of vibration, and then sing the same note back.

*Collapse of the Nimitz Freeway in an earthquake* *example 6*  
I led off the chapter with the dramatic collapse of the Tacoma Narrows Bridge, mainly because it was well documented by a local physics professor, and an unknown person made a movie of the collapse. The collapse a section of the Nimitz Freeway in Oakland, CA, during a 1989 earthquake is however a simpler example to analyze.

An earthquake consists of many low-frequency vibrations that occur simultaneously, which is why it sounds like a rumble of indeterminate pitch rather than a low hum. The frequencies that we can hear are not even the strongest ones; most of the energy is in the form of vibrations in the range of frequencies from about 1 Hz to 10 Hz.

Now all the structures we build are resting on geological layers of dirt, mud, sand, or rock. When an earthquake wave comes along, the top-most layer acts like a system with a certain natural frequency of vibration, sort of like a cube of jello on a plate being shaken from side to side. The resonant frequency of the layer depends on how stiff it is and also on how deep it is. The ill-fated section of the Nimitz freeway was built on a layer of mud, and analysis by geologist Susan E. Hough of the U.S. Geological Survey shows that the mud layer's resonance was centered on about 2.5 Hz, and had a width covering a range from about 1 Hz to 4 Hz.

When the earthquake wave came along with its mixture of frequencies, the mud responded strongly to those that were close to its own natural 2.5 Hz frequency. Unfortunately, an engineering analysis after the quake showed that the overpass itself had a resonant frequency of 2.5 Hz as well! The mud responded strongly to the earthquake waves with frequencies close to 2.5 Hz, and the bridge responded strongly to the 2.5 Hz vibrations of the mud, causing sections of it to collapse.



f / The collapsed section of the Nimitz Freeway.

Let's now examine the more conceptually difficult case of the Tacoma Narrows Bridge. The surprise here is that the wind was steady. If the wind was blowing at constant velocity, why did it shake the bridge back and forth? The answer is a little complicated. Based on film footage and after-the-fact wind tunnel experiments, it appears that two different mechanisms were involved.

The first mechanism was the one responsible for the initial, relatively weak vibrations, and it involved resonance. As the wind moved over the bridge, it began acting like a kite or an airplane wing. As shown in the figure, it established swirling patterns of air flow around itself, of the kind that you can see in a moving cloud of smoke. As one of these swirls moved off of the bridge, there was an abrupt change in air pressure, which resulted in an up or down force on the bridge. We see something similar when a flag flaps in the wind, except that the flag's surface is usually vertical. This back-and-forth sequence of forces is exactly the kind of periodic driving force that would excite a resonance. The faster the wind, the more quickly the swirls would get across the bridge, and the higher the frequency of the driving force would be. At just the right velocity, the frequency would be the right one to excite the resonance. The wind-tunnel models, however, show that the pattern of vibration of the bridge excited by this mechanism would have been a different one than the one that finally destroyed the bridge.

The bridge was probably destroyed by a different mechanism, in which its vibrations its own natural frequency of 0.2 Hz set up an alternating pattern of wind gusts in the air immediately around it, which then increased the amplitude of the bridge's vibrations. This vicious cycle fed upon itself, increasing the amplitude of the vibrations until the bridge finally collapsed.

As long as we're on the subject of collapsing bridges, it is worth bringing up the reports of bridges falling down when soldiers marching over them happened to step in rhythm with the bridge's natural frequency of oscillation. This is supposed to have happened in 1831 in Manchester, England, and again in 1849 in Anjou, France. Many modern engineers and scientists, however, are suspicious of the analysis of these reports. It is possible that the collapses had more to do with poor construction and overloading than with resonance. The Nimitz Freeway and Tacoma Narrows Bridge are far better documented, and occurred in an era when engineers' abilities to analyze the vibrations of a complex structure were much more advanced.

In a very thin gas, the atoms are sufficiently far apart that they can act as individual vibrating systems. Although the vibrations are of a very strange and abstract type described by the theory of quantum mechanics, they nevertheless obey the same basic rules as ordinary mechanical vibrations. When a thin gas made of a certain element is heated, it emits light waves with certain specific frequencies, which are like a fingerprint of that element. As with all other vibrations, these atomic vibrations respond most strongly to a driving force that matches their own natural frequency. Thus if we have a relatively cold gas with light waves of various frequencies passing through it, the gas will absorb light at

precisely those frequencies at which it would emit light if heated.

(3) When a system is driven at resonance, the steady-state vibrations have an amplitude that is proportional to  $Q$ .

This is fairly intuitive. The steady-state behavior is an equilibrium between energy input from the driving force and energy loss due to damping. A low- $Q$  oscillator, i.e., one with strong damping, dumps its energy faster, resulting in lower-amplitude steady-state motion.

*self-check C*

If an opera singer is shopping for a wine glass that she can impress her friends by breaking, what should she look for?      ▷ Answer, p. 101

*Piano strings ringing in sympathy with a sung note*      *example 9*

▷ A sufficiently loud musical note sung near a piano with the lid raised can cause the corresponding strings in the piano to vibrate. (A piano has a set of three strings for each note, all struck by the same hammer.) Why would this trick be unlikely to work with a violin?

▷ If you have heard the sound of a violin being plucked (the pizzicato effect), you know that the note dies away very quickly. In other words, a violin's  $Q$  is much lower than a piano's. This means that its resonances are much weaker in amplitude.

Our fourth and final fact about resonance is perhaps the most surprising. It gives us a way to determine numerically how wide a range of driving frequencies will produce a strong response. As shown in the graph, resonances do not suddenly fall off to zero outside a certain frequency range. It is usual to describe the width of a resonance by its full width at half-maximum (FWHM) as illustrated in figure g.

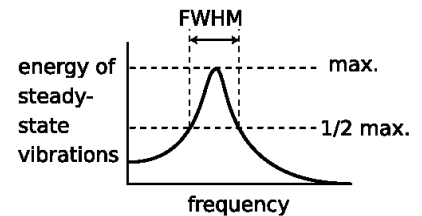

g / The definition of the full width at half maximum.

(4) The FWHM of a resonance is related to its  $Q$  and its resonant frequency  $f_{res}$  by the equation

$$\text{FWHM} = \frac{f_{res}}{Q} .$$

(This equation is only a good approximation when  $Q$  is large.)

Why? It is not immediately obvious that there should be any logical relationship between  $Q$  and the FWHM. Here's the idea. As we have seen already, the reason why the response of an oscillator is smaller away from resonance is that much of the driving force is being used to make the system act as if it had a different  $k$ . Roughly speaking, the half-maximum points on the graph correspond to the places where the amount of the driving force being wasted in this way is the same as the amount of driving force being used productively to replace the energy being dumped out by the damping force. If the damping force is strong, then a large amount of force is needed

to counteract it, and we can waste quite a bit of driving force on changing  $k$  before it becomes comparable to the  $\gamma$ . If, on the other hand, the damping force is weak, then even a small amount of force being wasted on changing  $k$  will become significant in proportion, and we cannot get very far from the resonant frequency before the two are comparable.

---

*Changing the pitch of a wind instrument*

*example 10*

▷ A saxophone player normally selects which note to play by choosing a certain fingering, which gives the saxophone a certain resonant frequency. The musician can also, however, change the pitch significantly by altering the tightness of her lips. This corresponds to driving the horn slightly off of resonance. If the pitch can be altered by about 5% up or down (about one musical half-step) without too much effort, roughly what is the  $Q$  of a saxophone?

▷ Five percent is the width on one side of the resonance, so the full width is about 10%,  $\text{FWHM} / f_{\text{res}} = 0.1$ . This implies a  $Q$  of about 10, i.e., once the musician stops blowing, the horn will continue sounding for about 10 cycles before its energy falls off by a factor of 535. (Blues and jazz saxophone players will typically choose a mouthpiece that has a low  $Q$ , so that they can produce the bluesy pitch-slides typical of their style. “Legit,” i.e., classically oriented players, use a higher- $Q$  setup because their style only calls for enough pitch variation to produce a vibrato.)

---

*Decay of a saxophone tone*

*example 11*

▷ If a typical saxophone setup has a  $Q$  of about 10, how long will it take for a 100-Hz tone played on a baritone saxophone to die down by a factor of 535 in energy, after the player suddenly stops blowing?

▷ A  $Q$  of 10 means that it takes 10 cycles for the vibrations to die down in energy by a factor of 535. Ten cycles at a frequency of 100 Hz would correspond to a time of 0.1 seconds, which is not very long. This is why a saxophone note doesn’t “ring” like a note played on a piano or an electric guitar.

---

*$Q$  of a radio receiver*

*example 12*

▷ A radio receiver used in the FM band needs to be tuned in to within about 0.1 MHz for signals at about 100 MHz. What is its  $Q$ ?

▷  $Q = f_{\text{res}}/\text{FWHM} = 1000$ . This is an extremely high  $Q$  compared to most mechanical systems.

---

*$Q$  of a stereo speaker*

*example 13*

We have already given one reason why a stereo speaker should have a low  $Q$ : otherwise it would continue ringing after the end of the musical note on the recording. The second reason is that we want it to be able to respond to a large range of frequencies.

### Nuclear magnetic resonance

### example 14

If you have ever played with a magnetic compass, you have undoubtedly noticed that if you shake it, it takes some time to settle down,  $\hbar/1$ . As it settles down, it acts like a damped oscillator of the type we have been discussing. The compass needle is simply a small magnet, and the planet earth is a big magnet. The magnetic forces between them tend to bring the needle to an equilibrium position in which it lines up with the planet-earth-magnet.

Essentially the same physics lies behind the technique called Nuclear Magnetic Resonance (NMR). NMR is a technique used to deduce the molecular structure of unknown chemical substances, and it is also used for making medical images of the inside of people's bodies. If you ever have an NMR scan, they will actually tell you you are undergoing "magnetic resonance imaging" or "MRI," because people are scared of the word "nuclear." In fact, the nuclei being referred to are simply the non-radioactive nuclei of atoms found naturally in your body.

Here's how NMR works. Your body contains large numbers of hydrogen atoms, each consisting of a small, lightweight electron orbiting around a large, heavy proton. That is, the nucleus of a hydrogen atom is just one proton. A proton is always spinning on its own axis, and the combination of its spin and its electrical charge cause it to behave like a tiny magnet. The principle identical to that of an electromagnet, which consists of a coil of wire through which electrical charges pass; the circling motion of the charges in the coil of wire makes it magnetic, and in the same way, the circling motion of the proton's charge makes it magnetic.

Now a proton in one of your body's hydrogen atoms finds itself surrounded by many other whirling, electrically charged particles: its own electron, plus the electrons and nuclei of the other nearby atoms. These neighbors act like magnets, and exert magnetic forces on the proton,  $\hbar/2$ . The  $k$  of the vibrating proton is simply a measure of the total strength of these magnetic forces. Depending on the structure of the molecule in which the hydrogen atom finds itself, there will be a particular set of magnetic forces acting on the proton and a particular value of  $k$ . The NMR apparatus bombards the sample with radio waves, and if the frequency of the radio waves matches the resonant frequency of the proton, the proton will absorb radio-wave energy strongly and oscillate wildly. Its vibrations are damped not by friction, because there is no friction inside an atom, but by the reemission of radio waves.

By working backward through this chain of reasoning, one can determine the geometric arrangement of the hydrogen atom's neighboring atoms. It is also possible to locate atoms in space, allowing medical images to be made.

Finally, it should be noted that the behavior of the proton cannot be described entirely correctly by Newtonian physics. Its vibrations are of the strange and spooky kind described by the laws of quantum mechanics. It is impressive, however, that the few simple ideas we have learned about resonance can still be applied successfully to describe many aspects of this exotic system.

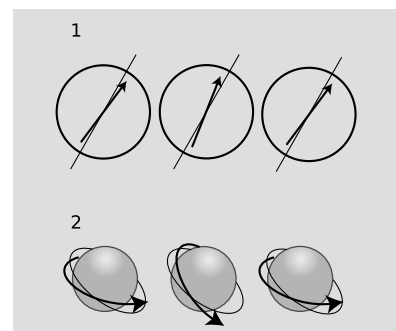

$\hbar$  / Example 14. 1. A compass needle vibrates about the equilibrium position under the influence of the earth's magnetic forces. 2. The orientation of a proton's spin vibrates around its equilibrium direction under the influence of the magnetic forces coming from the surrounding electrons and nuclei.

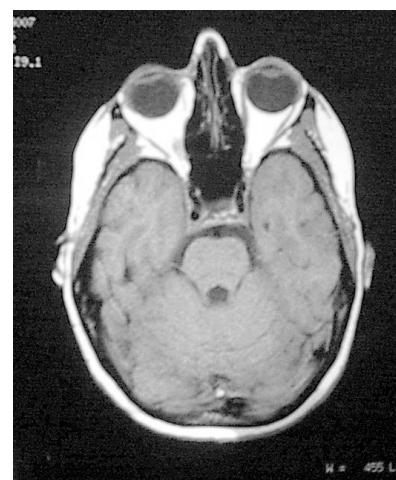

i / A member of the author's family, who turned out to be healthy.

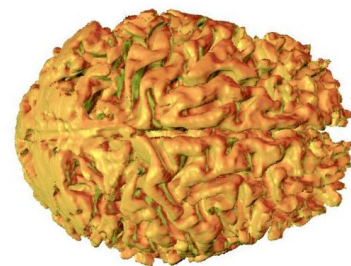

j / A three-dimensional computer reconstruction of the shape of a human brain, based on magnetic resonance data.

### Discussion Question

**A** Nikola Tesla, one of the inventors of radio and an archetypical mad scientist, told a credulous reporter the following story about an application of resonance. He built an electric vibrator that fit in his pocket, and attached it to one of the steel beams of a building that was under construction in New York. Although the article in which he was quoted didn't say so, he presumably claimed to have tuned it to the resonant frequency of the building. "In a few minutes, I could feel the beam trembling. Gradually the trembling increased in intensity and extended throughout the whole great mass of steel. Finally, the structure began to creak and weave, and the steelworkers came to the ground panic-stricken, believing that there had been an earthquake. ... [If] I had kept on ten minutes more, I could have laid that building flat in the street." Is this physically plausible?

## 2.4 ★ Proofs

Our first goal is to predict the amplitude of the steady-state vibrations as a function of the frequency of the driving force and the amplitude of the driving force. With that equation in hand, we will then prove statements 2, 3, and 4 from the previous section. We assume without proof statement 1, that the steady-state motion occurs at the same frequency as the driving force.

As with the proof in chapter 1, we make use of the fact that a sinusoidal vibration is the same as the projection of circular motion onto a line. We visualize the system shown in figures k-m, in which the mass swings in a circle on the end of a spring. The spring does not actually change its length at all, but it appears to from the flattened perspective of a person viewing the system edge-on. The radius of the circle is the amplitude,  $A$ , of the vibrations as seen edge-on. The damping force can be imagined as a backward drag force supplied by some fluid through which the mass is moving. As usual, we assume that the damping is proportional to velocity, and we use the symbol  $b$  for the proportionality constant,  $|F_d| = bv$ . The driving force, represented by a hand towing the mass with a string, has a tangential component  $|F_t|$  which counteracts the damping force,  $|F_t| = |F_d|$ , and a radial component  $F_r$  which works either with or against the spring's force, depending on whether we are driving the system above or below its resonant frequency.

The speed of the rotating mass is the circumference of the circle divided by the period,  $v = 2\pi A/T$ , its acceleration (which is directly inward) is  $a = v^2/r$ , and Newton's second law gives  $a = F/m = (kA + F_r)/m$ . We write  $f_{res}$  for  $\frac{1}{2\pi}\sqrt{k/m}$ . Straightforward algebra yields

$$[1] \quad \frac{F_r}{F_t} = \frac{2\pi m}{bf} (f^2 - f_{res}^2) \quad .$$

This is the ratio of the wasted force to the useful force, and we see that it becomes zero when the system is driven at resonance.

The amplitude of the vibrations can be found by attacking the equation  $|F_t| = bv = 2\pi bAf$ , which gives

$$[2] \quad A = \frac{|F_t|}{2\pi bf} \quad .(2)$$

However, we wish to know the amplitude in terms of  $\mathbf{F}$ , not  $|F_t|$ . From now on, let's drop the cumbersome magnitude symbols. With the Pythagorean theorem, it is easily proven that

$$[3] \quad F_t = \frac{F}{\sqrt{1 + \left(\frac{F_r}{F_t}\right)^2}} \quad , (3)$$

and equations 1-3 can then be combined to give the final result

$$[4] \quad A = \frac{F}{2\pi\sqrt{4\pi^2 m^2 (f^2 - f_{res}^2)^2 + b^2 f^2}} \quad .$$

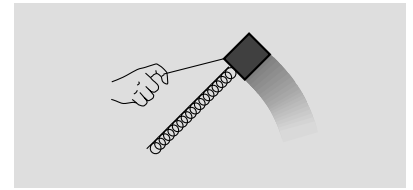

k / Driving at a frequency above resonance.

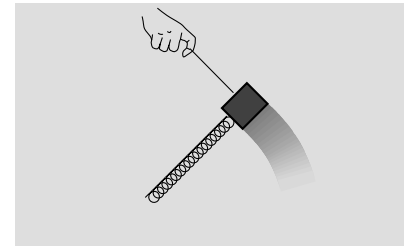

l / Driving at resonance.

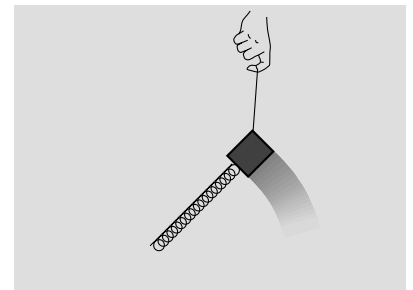

m / Driving at a frequency below resonance.

### Statement 2: maximum amplitude at resonance

Equation 4 shows directly that the amplitude is maximized when the system is driven at its resonant frequency. At resonance, the first term inside the square root vanishes, and this makes the denominator as small as possible, causing the amplitude to be as big as possible. (Actually this is only approximately true, because it is possible to make  $A$  a little bigger by decreasing  $f$  a little below  $f_{res}$ , which makes the second term smaller. This technical issue is addressed in homework problem 3 on page 43.)

### Statement 3: amplitude at resonance proportional to $Q$

Equation 4 shows that the amplitude at resonance is proportional to  $1/b$ , and the  $Q$  of the system is inversely proportional to  $b$ , so the amplitude at resonance is proportional to  $Q$ .

### Statement 4: FWHM related to $Q$

We will satisfy ourselves by proving only the proportionality  $FWHM \propto f_{res}/Q$ , not the actual equation  $FWHM = f_{res}/Q$ . The energy is proportional to  $A^2$ , i.e., to the inverse of the quantity inside the square root in equation 4. At resonance, the first term inside the square root vanishes, and the half-maximum points occur at frequencies for which the whole quantity inside the square root is double its value at resonance, i.e., when the two terms are equal. At the half-maximum points, we have

$$\begin{aligned} f^2 - f_{res}^2 &= \left( f_{res} \pm \frac{FWHM}{2} \right)^2 - f_{res}^2 \\ &= \pm f_{res} \cdot FWHM + \frac{1}{4} FWHM^2 \end{aligned}$$

If we assume that the width of the resonance is small compared to the resonant frequency, then the  $FWHM^2$  term is negligible compared to the  $f_{res} \cdot FWHM$  term, and setting the terms in equation 4 equal to each other gives

$$4\pi^2 m^2 (f_{res} FWHM)^2 = b^2 f^2 \quad .$$

We are assuming that the width of the resonance is small compared to the resonant frequency, so  $f$  and  $f_{res}$  can be taken as synonyms. Thus,

$$FWHM = \frac{b}{2\pi m} \quad .$$

We wish to connect this to  $Q$ , which can be interpreted as the energy of the free (undriven) vibrations divided by the work done by damping in one cycle. The former equals  $kA^2/2$ , and the latter is proportional to the force,  $bv \propto bAf_{res}$ , multiplied by the distance traveled,  $A$ . (This is only a proportionality, not an equation, since the force is not constant.) We therefore find that  $Q$  is proportional to  $k/bf_{res}$ . The equation for the FWHM can then be restated as a proportionality  $FWHM \propto k/Qf_{res}m \propto f_{res}/Q$ .



## Summary

### Selected Vocabulary

damping . . . . .	the dissipation of a vibration's energy into heat energy, or the frictional force that causes the loss of energy
quality factor . . .	the number of oscillations required for a system's energy to fall off by a factor of 535 due to damping
driving force . . .	an external force that pumps energy into a vibrating system
resonance . . . . .	the tendency of a vibrating system to respond most strongly to a driving force whose frequency is close to its own natural frequency of vibration
steady state . . . .	the behavior of a vibrating system after it has had plenty of time to settle into a steady response to a driving force

### Notation

$Q$ . . . . .	the quality factor
$f_{res}$ . . . . .	the natural (resonant) frequency of a vibrating system, i.e., the frequency at which it would vibrate if it was simply kicked and left alone
$f$ . . . . .	the frequency at which the system actually vibrates, which in the case of a driven system is equal to the frequency of the driving force, not the natural frequency

## Summary

The energy of a vibration is always proportional to the square of the amplitude, assuming the amplitude is small. Energy is lost from a vibrating system for various reasons such as the conversion to heat via friction or the emission of sound. This effect, called damping, will cause the vibrations to decay exponentially unless energy is pumped into the system to replace the loss. A driving force that pumps energy into the system may drive the system at its own natural frequency or at some other frequency. When a vibrating system is driven by an external force, we are usually interested in its steady-state behavior, i.e., its behavior after it has had time to settle into a steady response to a driving force. In the steady state, the same amount of energy is pumped into the system during each cycle as is lost to damping during the same period.

The following are four important facts about a vibrating system being driven by an external force:

- (1) The steady-state response to a sinusoidal driving force occurs at the frequency of the force, not at the system's own natural frequency of vibration.

(2) A vibrating system resonates at its own natural frequency. That is, the amplitude of the steady-state response is greatest in proportion to the amount of driving force when the driving force matches the natural frequency of vibration.

(3) When a system is driven at resonance, the steady-state vibrations have an amplitude that is proportional to  $Q$ .

(4) The FWHM of a resonance is related to its  $Q$  and its resonant frequency  $f_{res}$  by the equation

$$\text{FWHM} = \frac{f_{res}}{Q}.$$

(This equation is only a good approximation when  $Q$  is large.)

## Problems

### Key

- ✓ A computerized answer check is available online.
- ∫ A problem that requires calculus.
- ★ A difficult problem.

**1** If one stereo system is capable of producing 20 watts of sound power and another can put out 50 watts, how many times greater is the amplitude of the sound wave that can be created by the more powerful system? (Assume they are playing the same music.)

**2** Many fish have an organ known as a swim bladder, an air-filled cavity whose main purpose is to control the fish's buoyancy and allow it to keep from rising or sinking without having to use its muscles. In some fish, however, the swim bladder (or a small extension of it) is linked to the ear and serves the additional purpose of amplifying sound waves. For a typical fish having such an anatomy, the bladder has a resonant frequency of 300 Hz, the bladder's  $Q$  is 3, and the maximum amplification is about a factor of 100 in energy. Over what range of frequencies would the amplification be at least a factor of 50?

**3** As noted in section 2.4, it is only approximately true that the amplitude has its maximum at  $f = (1/2\pi)\sqrt{k/m}$ . Being more careful, we should actually define two different symbols,  $f_0 = (1/2\pi)\sqrt{k/m}$  and  $f_{res}$  for the slightly different frequency at which the amplitude is a maximum, i.e., the actual resonant frequency. In this notation, the amplitude as a function of frequency is

$$A = \frac{F}{2\pi\sqrt{4\pi^2 m^2 (f^2 - f_0^2)^2 + b^2 f^2}} .$$

Show that the maximum occurs not at  $f_0$  but rather at the frequency

$$f_{res} = \sqrt{f_0^2 - \frac{b^2}{8\pi^2 m^2}} = \sqrt{f_0^2 - \frac{1}{2}\text{FWHM}^2}$$

Hint: Finding the frequency that minimizes the quantity inside the square root is equivalent to, but much easier than, finding the frequency that maximizes the amplitude. ∫

**4** (a) Let  $W$  be the amount of work done by friction in the first cycle of oscillation, i.e., the amount of energy lost to heat. Find the fraction of the original energy  $E$  that remains in the oscillations after  $n$  cycles of motion.

(b) From this prove the equation (recalling that the number 535 in the definition of  $Q$  is  $e^{2\pi}$ ).

(c) Use this to prove the approximation  $1/Q \approx (1/2\pi)W/E$ . (Hint: Use the approximation  $\ln(1+x) \approx x$ , which is valid for small values of  $x$ .)

**5** The goal of this problem is to refine the proportionality  $\text{FWHM} \propto f_{\text{res}}/Q$  into the equation  $\text{FWHM} = f_{\text{res}}/Q$ , i.e., to prove that the constant of proportionality equals 1.

(a) Show that the work done by a damping force  $F = -bv$  over one cycle of steady-state motion equals  $W_{\text{damp}} = -2\pi^2bfA^2$ . Hint: It is less confusing to calculate the work done over half a cycle, from  $x = -A$  to  $x = +A$ , and then double it.

(b) Show that the fraction of the undriven oscillator's energy lost to damping over one cycle is  $|W_{\text{damp}}|/E = 4\pi^2bf/k$ .

(c) Use the previous result, combined with the result of problem 4, to prove that  $Q$  equals  $k/2\pi bf$ .

(d) Combine the preceding result for  $Q$  with the equation  $\text{FWHM} = b/2\pi m$  from section 2.4 to prove the equation  $\text{FWHM} = f_{\text{res}}/Q$ .

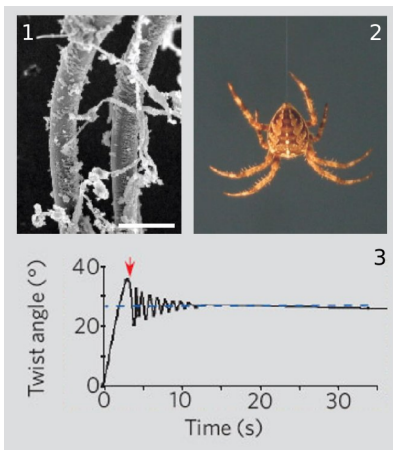

Problem 6.

**6** The figure is from *Shape memory in Spider draglines*, Emile, Le Floch, and Vollrath, *Nature* 440:621 (2006). Panel 1 shows an electron microscope's image of a thread of spider silk. In 2, a spider is hanging from such a thread. From an evolutionary point of view, it's probably a bad thing for the spider if it twists back and forth while hanging like this. (We're referring to a back-and-forth rotation about the axis of the thread, not a swinging motion like a pendulum.) The authors speculate that such a vibration could make the spider easier for predators to see, and it also seems to me that it would be a bad thing just because the spider wouldn't be able to control its orientation and do what it was trying to do. Panel 3 shows a graph of such an oscillation, which the authors measured using a video camera and a computer, with a 0.1 g mass hung from it in place of a spider. Compared to human-made fibers such as kevlar or copper wire, the spider thread has an unusual set of properties:

1. It has a low  $Q$ , so the vibrations damp out quickly.
2. It doesn't become brittle with repeated twisting as a copper wire would.
3. When twisted, it tends to settle in to a new equilibrium angle, rather than insisting on returning to its original angle. You can see this in panel 2, because although the experimenters initially twisted the wire by 33 degrees, the thread only performed oscillations with an amplitude much smaller than  $\pm 35$  degrees, settling down to a new equilibrium at 27 degrees.
4. Over much longer time scales (hours), the thread eventually resets itself to its original equilibrium angle (shown as zero degrees on the graph). (The graph reproduced here only shows the motion over a much shorter time scale.) Some human-made materials have this "memory" property as well, but they

typically need to be heated in order to make them go back to their original shapes.

Focusing on property number 1, estimate the  $Q$  of spider silk from the graph.





“The Great Wave Off Kanagawa,” by Katsushika Hokusai (1760-1849).

## Chapter 3

# Free Waves

Your vocal cords or a saxophone reed can vibrate, but being able to vibrate wouldn't be of much use unless the vibrations could be transmitted to the listener's ear by sound waves. What are waves and why do they exist? Put your fingertip in the middle of a cup of water and then remove it suddenly. You will have noticed two results that are surprising to most people. First, the flat surface of the water does not simply sink uniformly to fill in the volume vacated by your finger. Instead, ripples spread out, and the process of flattening out occurs over a long period of time, during which the water at the center vibrates above and below the normal water level. This type of wave motion is the topic of the present chapter. Second, you have found that the ripples bounce off of the walls of the cup, in much the same way that a ball would bounce off of a wall. In the next chapter we discuss what happens to waves that have a boundary around them. Until then, we confine ourselves to wave phenomena that can be analyzed as if the medium (e.g., the water) was infinite and the same everywhere.

It isn't hard to understand why removing your fingertip creates ripples rather than simply allowing the water to sink back down uniformly. The initial crater, (a), left behind by your finger has sloping sides, and the water next to the crater flows downhill to fill in the hole. The water far away, on the other hand, initially has no way of knowing what has happened, because there is no slope

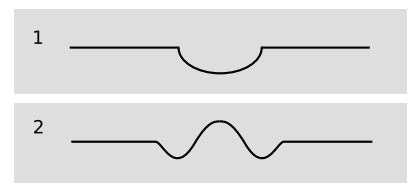

a / Dipping a finger in some water, 1, causes a disturbance that spreads outward, 2.

for it to flow down. As the hole fills up, the rising water at the center gains upward momentum, and overshoots, creating a little hill where there had been a hole originally. The area just outside of this region has been robbed of some of its water in order to build the hill, so a depressed “moat” is formed, (b). This effect cascades outward, producing ripples.





b / The two circular patterns of ripples pass through each other. Unlike material objects, wave patterns can overlap in space, and when this happens they combine by addition.

### 3.1 Wave Motion

There are three main ways in which wave motion differs from the motion of objects made of matter.

#### 1. Superposition

The most profound difference is that waves do not display anything analogous to the normal forces between objects that come in contact. Two wave patterns can therefore overlap in the same region of space, as shown in figure b. Where the two waves coincide, they add together. For instance, suppose that at a certain location in at a certain moment in time, each wave would have had a crest 3 cm above the normal water level. The waves combine at this point to make a 6-cm crest. We use negative numbers to represent depressions in the water. If both waves would have had a troughs measuring -3 cm, then they combine to make an extra-deep -6 cm trough. A +3 cm crest and a -3 cm trough result in a height of zero, i.e., the waves momentarily cancel each other out at that point. This additive rule is referred to as the principle of superposition, “superposition” being merely a fancy word for “adding.”

Superposition can occur not just with sinusoidal waves like the ones in the figure above but with waves of any shape. The figures on the following page show superposition of wave *pulses*. A pulse is simply a wave of very short duration. These pulses consist only of a single hump or trough. If you hit a clothesline sharply, you will observe pulses heading off in both directions. This is analogous to

the way ripples spread out in all directions when you make a disturbance at one point on water. The same occurs when the hammer on a piano comes up and hits a string.

Experiments to date have not shown any deviation from the principle of superposition in the case of light waves. For other types of waves, it is typically a very good approximation for low-energy waves.

### Discussion Question

**A** In figure c, the fifth frame shows the spring just about perfectly flat. If the two pulses have essentially canceled each other out perfectly, then why does the motion pick up again? Why doesn't the spring just stay flat?

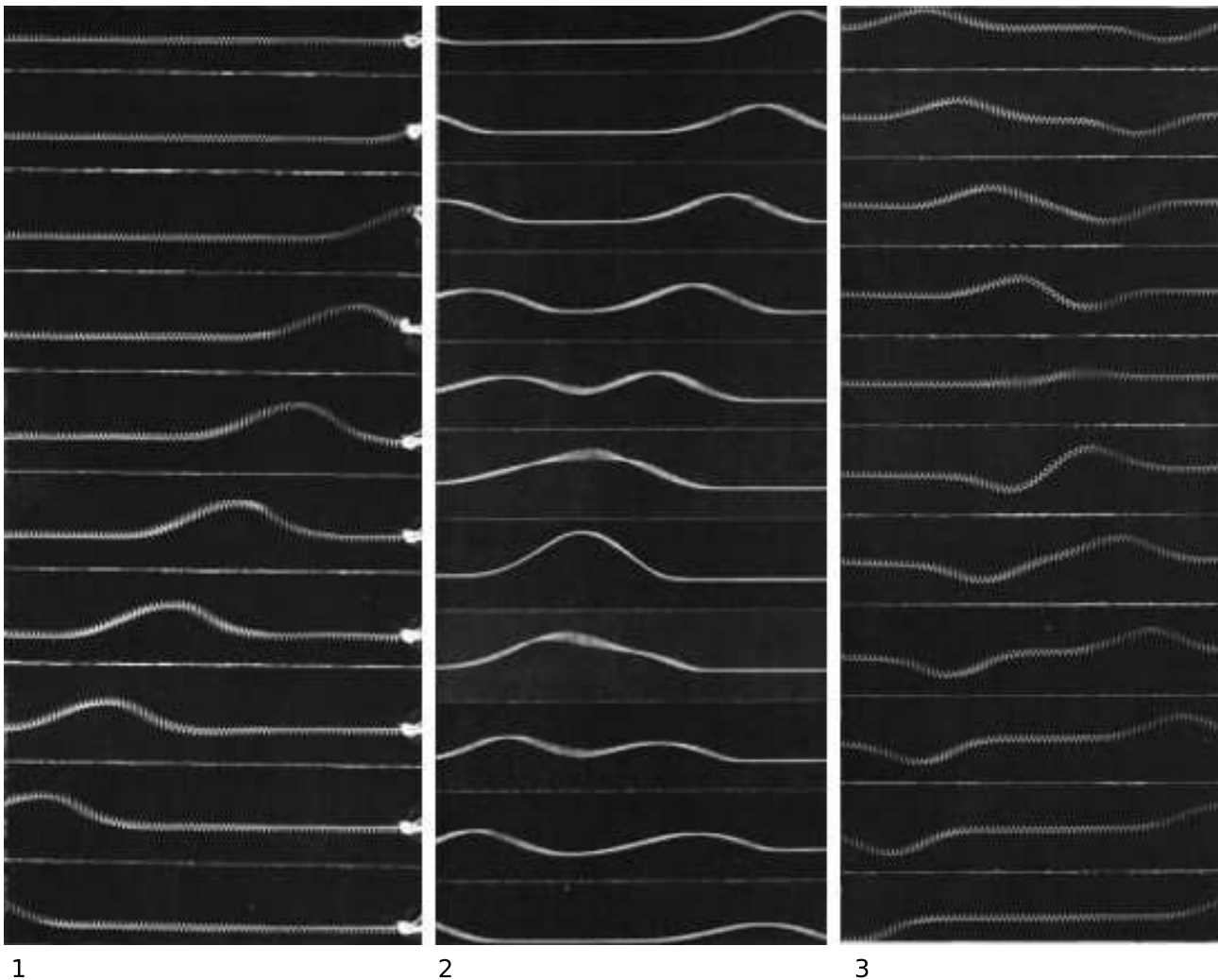

c / These pictures show the motion of wave pulses along a spring. To make a pulse, one end of the spring was shaken by hand. Movies were filmed, and a series of frame chosen to show the motion. 1. A pulse travels to the left. 2. Superposition of two colliding positive pulses. 3. Superposition of two colliding pulses, one positive and one negative.

You can download this book for free, or buy a printed copy, at [lightandmatter.com](http://lightandmatter.com). It's available under the Creative Commons Attribution-ShareAlike license, [creativecommons.org/licenses/by-sa/1.0](http://creativecommons.org/licenses/by-sa/1.0). (c) 1998-2005 Benjamin Crowell.

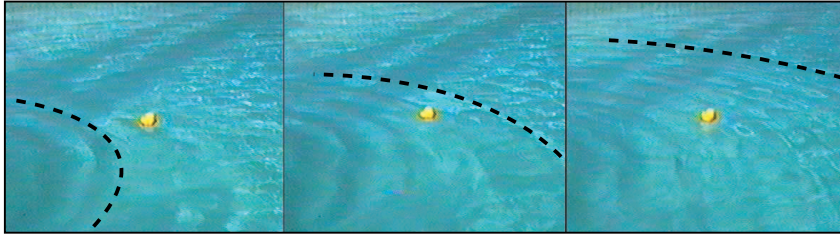

d / As the wave pattern passes the rubber duck, the duck stays put. The water isn't moving forward with the wave.

## 2. The medium is not transported with the wave.

Figure d shows a series of water waves before it has reached a rubber duck (left), having just passed the duck (middle) and having progressed about a meter beyond the duck (right). The duck bobs around its initial position, but is not carried along with the wave. This shows that the water itself does not flow outward with the wave. If it did, we could empty one end of a swimming pool simply by kicking up waves! We must distinguish between the motion of the medium (water in this case) and the motion of the wave pattern through the medium. The medium vibrates; the wave progresses through space.

### self-check A

In figure e, you can detect the side-to-side motion of the spring because the spring appears blurry. At a certain instant, represented by a single photo, how would you describe the motion of the different parts of the spring? Other than the flat parts, do any parts of the spring have zero velocity?

▷ Answer, p. 101

### A worm

### example 1

The worm in the figure is moving to the right. The wave pattern, a pulse consisting of a compressed area of its body, moves to the left. In other words, the motion of the wave pattern is in the opposite direction compared to the motion of the medium.

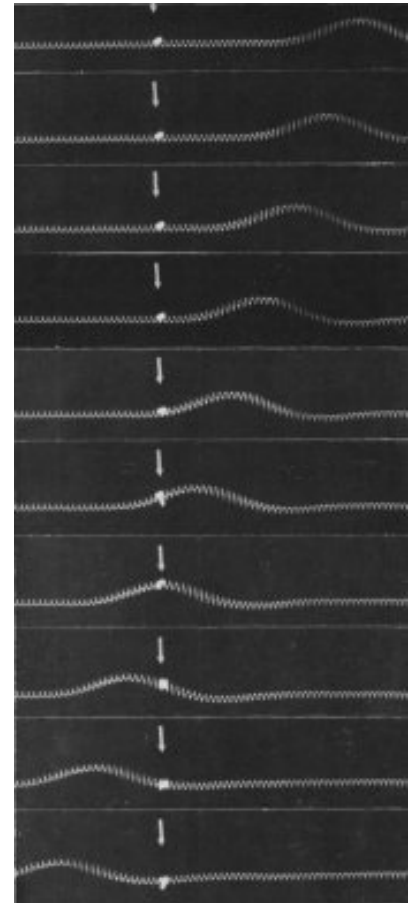
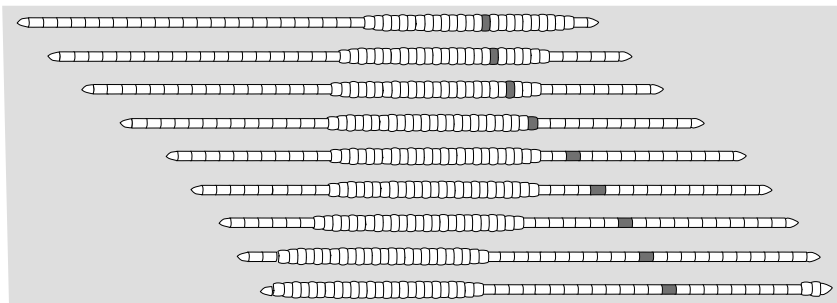

e / As the wave pulse goes by, the ribbon tied to the spring is not carried along. The motion of the wave pattern is to the right, but the medium (spring) is moving up and down, not to the right.



f / Example 2. The surfer is dragging his hand in the water.

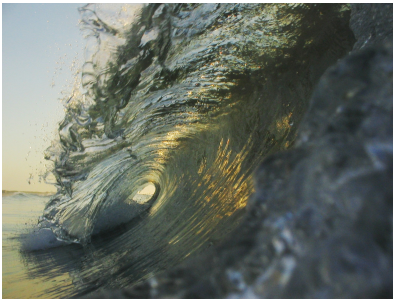

g / Example 3: a breaking wave.

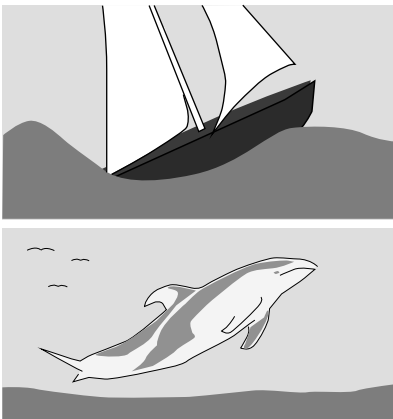

h / Example 4. The boat has run up against a limit on its speed because it can't climb over its own wave. Dolphins get around the problem by leaping out of the water.

*Surfing*

*example 2*

The incorrect belief that the medium moves with the wave is often reinforced by garbled secondhand knowledge of surfing. Anyone who has actually surfed knows that the front of the board pushes the water to the sides, creating a wake — the surfer can even drag his hand through the water, as in in figure f. If the water was moving along with the wave and the surfer, this wouldn't happen. The surfer is carried forward because forward is downhill, not because of any forward flow of the water. If the water was flowing forward, then a person floating in the water up to her neck would be carried along just as quickly as someone on a surfboard. In fact, it is even possible to surf down the back side of a wave, although the ride wouldn't last very long because the surfer and the wave would quickly part company.

**3. A wave's velocity depends on the medium.**

A material object can move with any velocity, and can be sped up or slowed down by a force that increases or decreases its kinetic energy. Not so with waves. The magnitude of a wave's velocity depends on the properties of the medium (and perhaps also on the shape of the wave, for certain types of waves). Sound waves travel at about 340 m/s in air, 1000 m/s in helium. If you kick up water waves in a pool, you will find that kicking harder makes waves that are taller (and therefore carry more energy), not faster. The sound waves from an exploding stick of dynamite carry a lot of energy, but are no faster than any other waves. In the following section we will give an example of the physical relationship between the wave speed and the properties of the medium.

*Breaking waves*

*example 3*

The velocity of water waves increases with depth. The crest of a wave travels faster than the trough, and this can cause the wave to break.

Once a wave is created, the only reason its speed will change is if it enters a different medium or if the properties of the medium change. It is not so surprising that a change in medium can slow down a wave, but the reverse can also happen. A sound wave traveling through a helium balloon will slow down when it emerges into the air, but if it enters another balloon it will speed back up again! Similarly, water waves travel more quickly over deeper water, so a wave will slow down as it passes over an underwater ridge, but speed up again as it emerges into deeper water.

*Hull speed*

*example 4*

The speeds of most boats, and of some surface-swimming animals, are limited by the fact that they make a wave due to their motion through the water. The boat in figure h is going at the same speed as its own waves, and can't go any faster. No matter how hard the boat pushes against the water, it can't make the wave move ahead faster and get out of the way. The wave's speed depends only on the medium. Adding energy to

the wave doesn't speed it up, it just increases its amplitude.

A water wave, unlike many other types of wave, has a speed that depends on its shape: a broader wave moves faster. The shape of the wave made by a boat tends to mold itself to the shape of the boat's hull, so a boat with a longer hull makes a broader wave that moves faster. The maximum speed of a boat whose speed is limited by this effect is therefore closely related to the length of its hull, and the maximum speed is called the hull speed. Sailboats designed for racing are not just long and skinny to make them more streamlined — they are also long so that their hull speeds will be high.

### Wave patterns

If the magnitude of a wave's velocity vector is preordained, what about its direction? Waves spread out in all directions from every point on the disturbance that created them. If the disturbance is small, we may consider it as a single point, and in the case of water waves the resulting wave pattern is the familiar circular ripple, i/1. If, on the other hand, we lay a pole on the surface of the water and wiggle it up and down, we create a linear wave pattern, i/2. For a three-dimensional wave such as a sound wave, the analogous patterns would be spherical waves and plane waves, j.

Infinitely many patterns are possible, but linear or plane waves are often the simplest to analyze, because the velocity vector is in the same direction no matter what part of the wave we look at. Since all the velocity vectors are parallel to one another, the problem is effectively one-dimensional. Throughout this chapter and the next, we will restrict ourselves mainly to wave motion in one dimension, while not hesitating to broaden our horizons when it can be done without too much complication.

### Discussion Questions

- A [see above]
- B Sketch two positive wave pulses on a string that are overlapping but not right on top of each other, and draw their superposition. Do the same for a positive pulse running into a negative pulse.
- C A traveling wave pulse is moving to the right on a string. Sketch the velocity vectors of the various parts of the string. Now do the same for a pulse moving to the left.
- D In a spherical sound wave spreading out from a point, how would the energy of the wave fall off with distance?

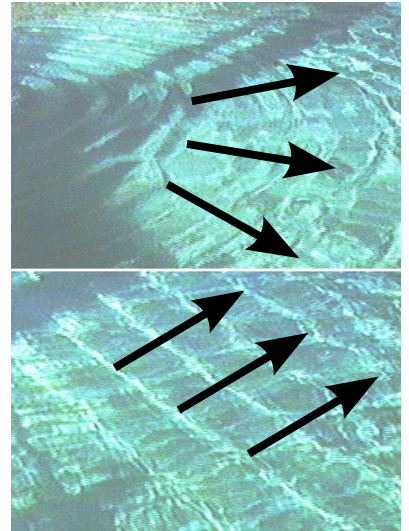

i / Circular and linear wave patterns.

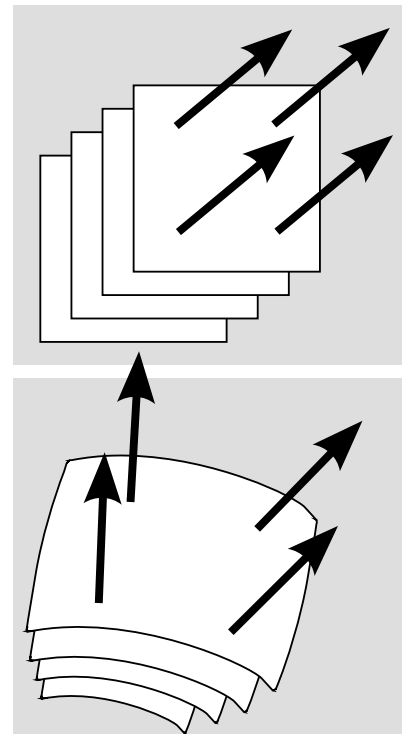

j / Plane and spherical wave patterns.

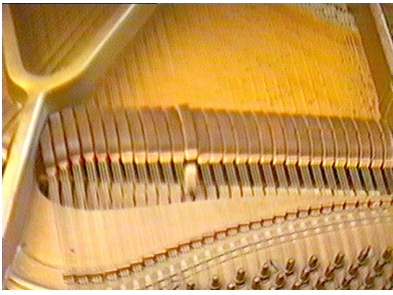

k / Hitting a key on a piano causes a hammer to come up from underneath and hit a string (actually a set of three strings). The result is a pair of pulses moving away from the point of impact.

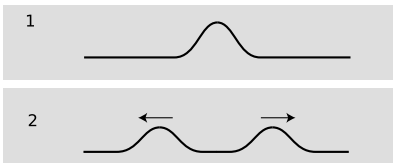

l / A string is struck with a hammer, 1, and two pulses fly off, 2.

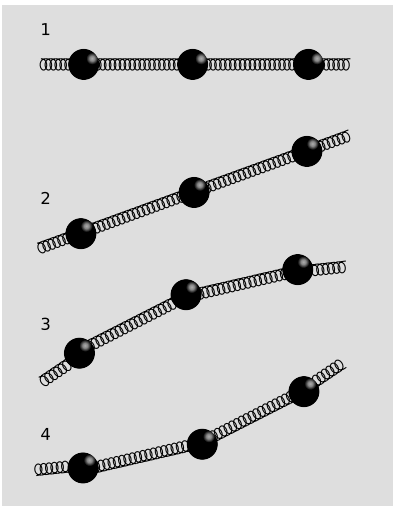

m / A continuous string can be modeled as a series of discrete masses connected by springs.

## 3.2 Waves on a String

So far you have learned some counterintuitive things about the behavior of waves, but intuition can be trained. The first half of this section aims to build your intuition by investigating a simple, one-dimensional type of wave: a wave on a string. If you have ever stretched a string between the bottoms of two open-mouthed cans to talk to a friend, you were putting this type of wave to work. Stringed instruments are another good example. Although we usually think of a piano wire simply as vibrating, the hammer actually strikes it quickly and makes a dent in it, which then ripples out in both directions. Since this chapter is about free waves, not bounded ones, we pretend that our string is infinitely long.

After the qualitative discussion, we will use simple approximations to investigate the speed of a wave pulse on a string. This quick and dirty treatment is then followed by a rigorous attack using the methods of calculus, which may be skipped by the student who has not studied calculus. How far you penetrate in this section is up to you, and depends on your mathematical self-confidence. If you skip the later parts and proceed to the next section, you should nevertheless be aware of the important result that the speed at which a pulse moves does not depend on the size or shape of the pulse. This is a fact that is true for many other types of waves.

### Intuitive ideas

Consider a string that has been struck, l/1, resulting in the creation of two wave pulses, 2, one traveling to the left and one to the right. This is analogous to the way ripples spread out in all directions from a splash in water, but on a one-dimensional string, “all directions” becomes “both directions.”

We can gain insight by modeling the string as a series of masses connected by springs. (In the actual string the mass and the springiness are both contributed by the molecules themselves.) If we look at various microscopic portions of the string, there will be some areas that are flat, m/1, some that are sloping but not curved, 2, and some that are curved, 3 and 4. In example 1 it is clear that both the forces on the central mass cancel out, so it will not accelerate. The same is true of 2, however. Only in curved regions such as 3 and 4 is an acceleration produced. In these examples, the vector sum of the two forces acting on the central mass is not zero. The important concept is that curvature makes force: the curved areas of a wave tend to experience forces resulting in an acceleration toward the mouth of the curve. Note, however, that an uncurved portion of the string need not remain motionless. It may move at constant velocity to either side.

## Approximate treatment

We now carry out an approximate treatment of the speed at which two pulses will spread out from an initial indentation on a string. For simplicity, we imagine a hammer blow that creates a triangular dent,  $n/1$ . We will estimate the amount of time,  $t$ , required until each of the pulses has traveled a distance equal to the width of the pulse itself. The velocity of the pulses is then  $\pm w/t$ .

As always, the velocity of a wave depends on the properties of the medium, in this case the string. The properties of the string can be summarized by two variables: the tension,  $T$ , and the mass per unit length,  $\mu$  (Greek letter mu).

If we consider the part of the string encompassed by the initial dent as a single object, then this object has a mass of approximately  $\mu w$  (mass/length  $\times$  length = mass). (Here, and throughout the derivation, we assume that  $h$  is much less than  $w$ , so that we can ignore the fact that this segment of the string has a length slightly greater than  $w$ .) Although the downward acceleration of this segment of the string will be neither constant over time nor uniform across the string, we will pretend that it is constant for the sake of our simple estimate. Roughly speaking, the time interval between  $n/1$  and 2 is the amount of time required for the initial dent to accelerate from rest and reach its normal, flattened position. Of course the tip of the triangle has a longer distance to travel than the edges, but again we ignore the complications and simply assume that the segment as a whole must travel a distance  $h$ . Indeed, it might seem surprising that the triangle would so neatly spring back to a perfectly flat shape. It is an experimental fact that it does, but our analysis is too crude to address such details.

The string is kinked, i.e., tightly curved, at the edges of the triangle, so it is here that there will be large forces that do not cancel out to zero. There are two forces acting on the triangular hump, one of magnitude  $T$  acting down and to the right, and one of the same magnitude acting down and to the left. If the angle of the sloping sides is  $\theta$ , then the total force on the segment equals  $2T \sin \theta$ . Dividing the triangle into two right triangles, we see that  $\sin \theta$  equals  $h$  divided by the length of one of the sloping sides. Since  $h$  is much less than  $w$ , the length of the sloping side is essentially the same as  $w/2$ , so we have  $\sin \theta = h/w$ , and  $F = 4Th/w$ . The acceleration of the segment (actually the acceleration of its center of mass) is

$$\begin{aligned} a &= F/m \\ &= 4Th/\mu w^2 \end{aligned} .$$

The time required to move a distance  $h$  under constant acceleration

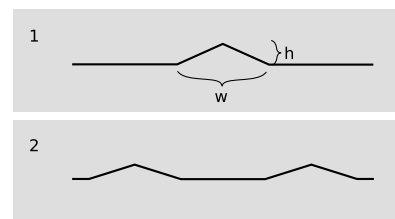

$n/1$  / A triangular pulse spreads out.

$a$  is found by solving  $h = \frac{1}{2}at^2$  to yield

$$\begin{aligned} t &= \sqrt{\frac{2h}{a}} \\ &= w\sqrt{\frac{\mu}{2T}} \quad . \end{aligned}$$

Our final result for the velocity of the pulses is

$$\begin{aligned} |v| &= \frac{w}{t} \\ &= \sqrt{\frac{2T}{\mu}} \quad . \end{aligned}$$

The remarkable feature of this result is that the velocity of the pulses does not depend at all on  $w$  or  $h$ , i.e., any triangular pulse has the same speed. It is an experimental fact (and we will also prove rigorously in the following subsection) that any pulse of any kind, triangular or otherwise, travels along the string at the same speed. Of course, after so many approximations we cannot expect to have gotten all the numerical factors right. The correct result for the velocity of the pulses is

$$v = \sqrt{\frac{T}{\mu}} \quad .$$

The importance of the above derivation lies in the insight it brings—that all pulses move with the same speed—rather than in the details of the numerical result. The reason for our too-high value for the velocity is not hard to guess. It comes from the assumption that the acceleration was constant, when actually the total force on the segment would diminish as it flattened out.

### Rigorous derivation using calculus (optional)

After expending considerable effort for an approximate solution, we now display the power of calculus with a rigorous and completely general treatment that is nevertheless much shorter and easier. Let the flat position of the string define the  $x$  axis, so that  $y$  measures how far a point on the string is from equilibrium. The motion of the string is characterized by  $y(x, t)$ , a function of two variables. Knowing that the force on any small segment of string depends on the curvature of the string in that area, and that the second derivative is a measure of curvature, it is not surprising to find that the infinitesimal force  $dF$  acting on an infinitesimal segment  $dx$  is given by

$$dF = T \frac{d^2y}{dx^2} dx \quad .$$

(This can be proved by vector addition of the two infinitesimal forces acting on either side.) The acceleration is then  $a = dF/dm$ , or,



substituting  $dm = \mu dx$ ,

$$\frac{d^2y}{dt^2} = \frac{T}{\mu} \frac{d^2y}{dx^2} .$$

The second derivative with respect to time is related to the second derivative with respect to position. This is no more than a fancy mathematical statement of the intuitive fact developed above, that the string accelerates so as to flatten out its curves.

Before even bothering to look for solutions to this equation, we note that it already proves the principle of superposition, because the derivative of a sum is the sum of the derivatives. Therefore the sum of any two solutions will also be a solution.

Based on experiment, we expect that this equation will be satisfied by any function  $y(x, t)$  that describes a pulse or wave pattern moving to the left or right at the correct speed  $v$ . In general, such a function will be of the form  $y = f(x - vt)$  or  $y = f(x + vt)$ , where  $f$  is any function of one variable. Because of the chain rule, each derivative with respect to time brings out a factor of  $\pm v$ . Evaluating the second derivatives on both sides of the equation gives

$$(\pm v)^2 f' = \frac{T}{\mu} f'' .$$

Squaring gets rid of the sign, and we find that we have a valid solution for any function  $f$ , provided that  $v$  is given by

$$v = \sqrt{\frac{T}{\mu}} .$$

## 3.3 Sound and Light Waves

### Sound waves

The phenomenon of sound is easily found to have all the characteristics we expect from a wave phenomenon:

- Sound waves obey superposition. Sounds do not knock other sounds out of the way when they collide, and we can hear more than one sound at once if they both reach our ear simultaneously.
- The medium does not move with the sound. Even standing in front of a titanic speaker playing earsplitting music, we do not feel the slightest breeze.
- The velocity of sound depends on the medium. Sound travels faster in helium than in air, and faster in water than in helium. Putting more energy into the wave makes it more intense, not faster. For example, you can easily detect an echo when you clap your hands a short distance from a large, flat wall, and the delay of the echo is no shorter for a louder clap.

Although not all waves have a speed that is independent of the shape of the wave, and this property therefore is irrelevant to our collection of evidence that sound is a wave phenomenon, sound does nevertheless have this property. For instance, the music in a large concert hall or stadium may take on the order of a second to reach someone seated in the nosebleed section, but we do not notice or care, because the delay is the same for every sound. Bass, drums, and vocals all head outward from the stage at 340 m/s, regardless of their differing wave shapes.

If sound has all the properties we expect from a wave, then what type of wave is it? It must be a vibration of a physical medium such as air, since the speed of sound is different in different media, such as helium or water. Further evidence is that we don't receive sound signals that have come to our planet through outer space. The roars and whooshes of Hollywood's space ships are fun, but scientifically wrong.<sup>1</sup>

We can also tell that sound waves consist of compressions and expansions, rather than sideways vibrations like the shimmying of a

---

<sup>1</sup>Outer space is not a perfect vacuum, so it is possible for sound waves to travel through it. However, if we want to create a sound wave, we typically do it by creating vibrations of a physical object, such as the sounding board of a guitar, the reed of a saxophone, or a speaker cone. The lower the density of the surrounding medium, the less efficiently the energy can be converted into sound and carried away. An isolated tuning fork, left to vibrate in interstellar space, would dissipate the energy of its vibration into internal heat at a rate many orders of magnitude greater than the rate of sound emission into the nearly perfect vacuum around it.

snake. Only compressional vibrations would be able to cause your eardrums to vibrate in and out. Even for a very loud sound, the compression is extremely weak; the increase or decrease compared to normal atmospheric pressure is no more than a part per million. Our ears are apparently very sensitive receivers!

## Light waves

Entirely similar observations lead us to believe that light is a wave, although the concept of light as a wave had a long and tortuous history. It is interesting to note that Isaac Newton very influentially advocated a contrary idea about light. The belief that matter was made of atoms was stylish at the time among radical thinkers (although there was no experimental evidence for their existence), and it seemed logical to Newton that light as well should be made of tiny particles, which he called corpuscles (Latin for “small objects”). Newton’s triumphs in the science of mechanics, i.e., the study of matter, brought him such great prestige that nobody bothered to question his incorrect theory of light for 150 years. One persuasive proof that light is a wave is that according to Newton’s theory, two intersecting beams of light should experience at least some disruption because of collisions between their corpuscles. Even if the corpuscles were extremely small, and collisions therefore very infrequent, at least some dimming should have been measurable. In fact, very delicate experiments have shown that there is no dimming.

The wave theory of light was entirely successful up until the 20th century, when it was discovered that not all the phenomena of light could be explained with a pure wave theory. It is now believed that both light and matter are made out of tiny chunks which have *both* wave and particle properties. For now, we will content ourselves with the wave theory of light, which is capable of explaining a great many things, from cameras to rainbows.

If light is a wave, what is waving? What is the medium that wiggles when a light wave goes by? It isn’t air. A vacuum is impenetrable to sound, but light from the stars travels happily through zillions of miles of empty space. Light bulbs have no air inside them, but that doesn’t prevent the light waves from leaving the filament. For a long time, physicists assumed that there must be a mysterious medium for light waves, and they called it the aether (not to be confused with the chemical). Supposedly the aether existed everywhere in space, and was immune to vacuum pumps. The details of the story are more fittingly reserved for later in this course, but the end result was that a long series of experiments failed to detect any evidence for the aether, and it is no longer believed to exist. Instead, light can be explained as a wave pattern made up of electrical and magnetic fields.

## 3.4 Periodic Waves

### Period and frequency of a periodic wave

You choose a radio station by selecting a certain frequency. We have already defined period and frequency for vibrations, but what do they signify in the case of a wave? We can recycle our previous definition simply by stating it in terms of the vibrations that the wave causes as it passes a receiving instrument at a certain point in space. For a sound wave, this receiver could be an eardrum or a microphone. If the vibrations of the eardrum repeat themselves over and over, i.e., are periodic, then we describe the sound wave that caused them as periodic. Likewise we can define the period and frequency of a wave in terms of the period and frequency of the vibrations it causes. As another example, a periodic water wave would be one that caused a rubber duck to bob in a periodic manner as they passed by it.

The period of a sound wave correlates with our sensory impression of musical pitch. A high frequency (short period) is a high note. The sounds that really define the musical notes of a song are only the ones that are periodic. It is not possible to sing a non-periodic sound like “sh” with a definite pitch.

The frequency of a light wave corresponds to color. Violet is the high-frequency end of the rainbow, red the low-frequency end. A color like brown that does not occur in a rainbow is not a periodic light wave. Many phenomena that we do not normally think of as light are actually just forms of light that are invisible because they fall outside the range of frequencies our eyes can detect. Beyond the red end of the visible rainbow, there are infrared and radio waves. Past the violet end, we have ultraviolet, x-rays, and gamma rays.

### Graphs of waves as a function of position

Some waves, light sound waves, are easy to study by placing a detector at a certain location in space and studying the motion as a function of time. The result is a graph whose horizontal axis is time. With a water wave, on the other hand, it is simpler just to look at the wave directly. This visual snapshot amounts to a graph of the height of the water wave as a function of *position*. Any wave can be represented in either way.

An easy way to visualize this is in terms of a strip chart recorder, an obsolescing device consisting of a pen that wiggles back and forth as a roll of paper is fed under it. It can be used to record a person’s electrocardiogram, or seismic waves too small to be felt as a noticeable earthquake but detectable by a seismometer. Taking the seismometer as an example, the chart is essentially a record of the ground’s wave motion as a function of time, but if the paper was set to feed at the same velocity as the motion of an earthquake wave, it would also be a full-scale representation of the profile of the actual

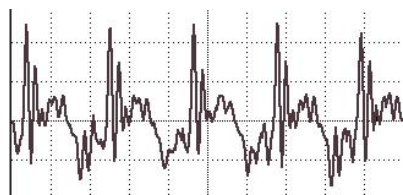

o / A graph of pressure versus time for a periodic sound wave, the vowel “ah.”

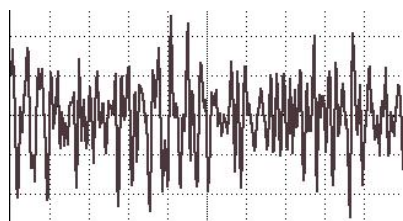

p / A similar graph for a non-periodic wave, “sh.”

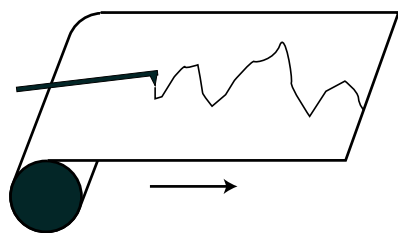

q / A strip chart recorder.

wave pattern itself. Assuming, as is usually the case, that the wave velocity is a constant number regardless of the wave's shape, knowing the wave motion as a function of time is equivalent to knowing it as a function of position.

### Wavelength

Any wave that is periodic will also display a repeating pattern when graphed as a function of position. The distance spanned by one repetition is referred to as one *wavelength*. The usual notation for wavelength is  $\lambda$ , the Greek letter lambda. Wavelength is to space as period is to time.

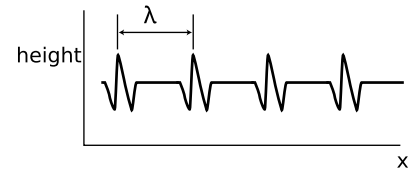

r / A water wave profile created by a series of repeating pulses.

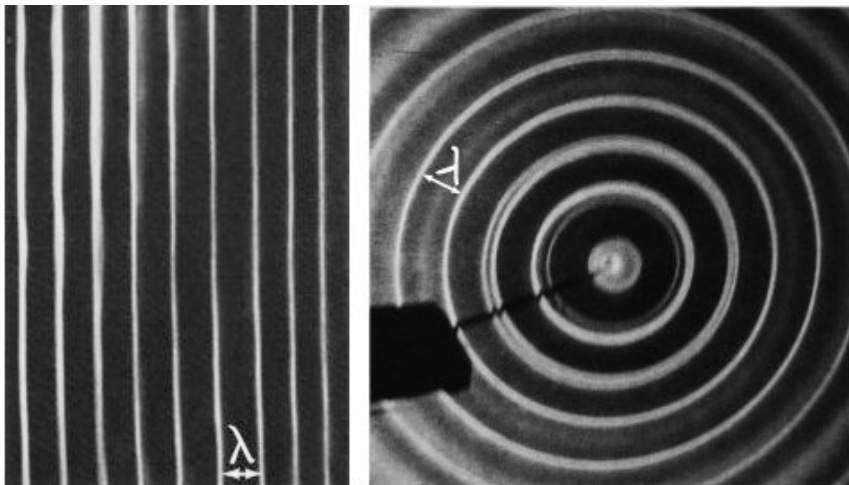

s / Wavelengths of linear and circular water waves.

### Wave velocity related to frequency and wavelength

Suppose that we create a repetitive disturbance by kicking the surface of a swimming pool. We are essentially making a series of wave pulses. The wavelength is simply the distance a pulse is able to travel before we make the next pulse. The distance between pulses is  $\lambda$ , and the time between pulses is the period,  $T$ , so the speed of the wave is the distance divided by the time,

$$v = \lambda/T.$$

This important and useful relationship is more commonly written in terms of the frequency,

$$v = f\lambda \quad .$$

#### Wavelength of radio waves

#### example 5

▷ The speed of light is  $3.0 \times 10^8$  m/s. What is the wavelength of the radio waves emitted by KKJZ, a station whose frequency is 88.1 MHz?

▷ Solving for wavelength, we have

$$\begin{aligned}\lambda &= v/f \\ &= (3.0 \times 10^8 \text{ m/s}) / (88.1 \times 10^6 \text{ s}^{-1}) \\ &= 3.4 \text{ m}\end{aligned}$$

The size of a radio antenna is closely related to the wavelength of the waves it is intended to receive. The match need not be exact (since after all one antenna can receive more than one wavelength!), but the ordinary “whip” antenna such as a car’s is 1/4 of a wavelength. An antenna optimized to receive KKJZ’s signal would have a length of  $3.4 \text{ m}/4 = 0.85 \text{ m}$ .

t / Ultrasound, i.e., sound with frequencies higher than the range of human hearing, was used to make this image of a fetus. The resolution of the image is related to the wavelength, since details smaller than about one wavelength cannot be resolved. High resolution therefore requires a short wavelength, corresponding to a high frequency.

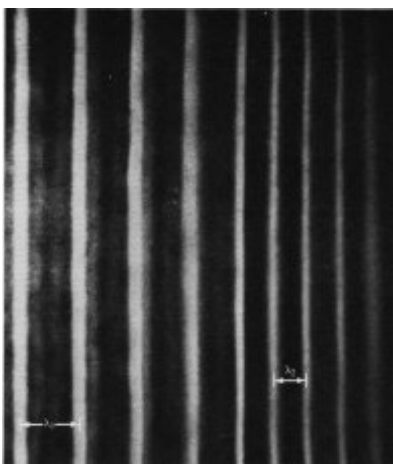
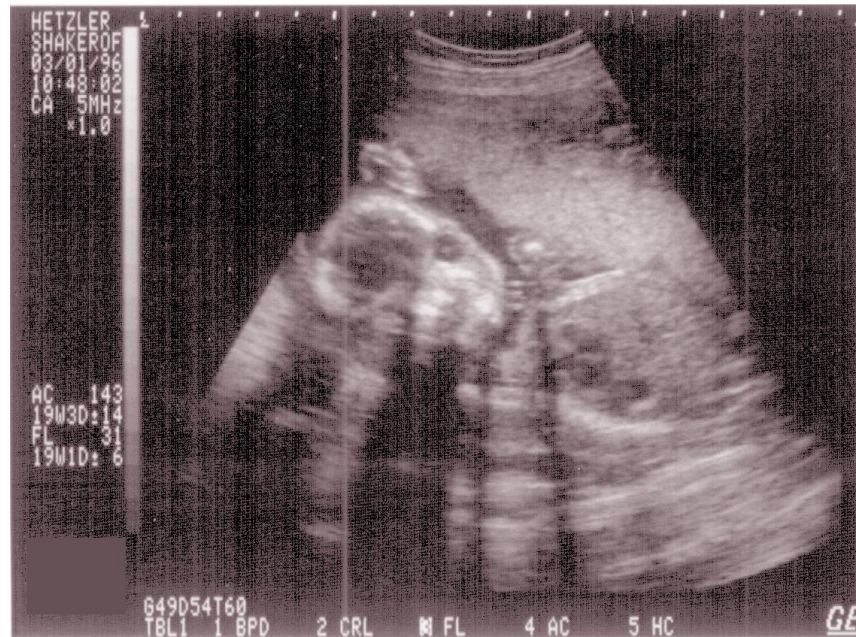

u / A water wave traveling into a region with a different depth changes its wavelength.

The equation  $v = f\lambda$  defines a fixed relationship between any two of the variables if the other is held fixed. The speed of radio waves in air is almost exactly the same for all wavelengths and frequencies (it is exactly the same if they are in a vacuum), so there is a fixed relationship between their frequency and wavelength. Thus we can say either “Are we on the same wavelength?” or “Are we on the same frequency?”

A different example is the behavior of a wave that travels from a region where the medium has one set of properties to an area where the medium behaves differently. The frequency is now fixed, because otherwise the two portions of the wave would otherwise get out of step, causing a kink or discontinuity at the boundary, which would be unphysical. (A more careful argument is that a kink or discontinuity would have infinite curvature, and waves tend to flatten out their curvature. An infinite curvature would flatten out infinitely fast, i.e., it could never occur in the first place.) Since

You can download this book for free, or buy a printed copy, at [lightandmatter.com](http://lightandmatter.com). It's available under the Creative Commons Attribution-ShareAlike license, [creativecommons.org/licenses/by-sa/1.0](http://creativecommons.org/licenses/by-sa/1.0). (c) 1998-2005 Benjamin Crowell.

the frequency must stay the same, any change in the velocity that results from the new medium must cause a change in wavelength.

The velocity of water waves depends on the depth of the water, so based on  $\lambda = v/f$ , we see that water waves that move into a region of different depth must change their wavelength, as shown in the figure on the left. This effect can be observed when ocean waves come up to the shore. If the deceleration of the wave pattern is sudden enough, the tip of the wave can curl over, resulting in a breaking wave.

---

**A note on dispersive waves**

The discussion of wave velocity given here is actually an oversimplification for a wave whose velocity depends on its frequency and wavelength. Such a wave is called a dispersive wave. Nearly all the waves we deal with in this course are non-dispersive, but the issue becomes important in book 6 of this series, where it is discussed in more detail in optional section 4.2.

### Sinusoidal waves

Sinusoidal waves are the most important special case of periodic waves. In fact, many scientists and engineers would be uncomfortable with defining a waveform like the “ah” vowel sound as having a definite frequency and wavelength, because they consider only sine waves to be pure examples of a certain frequency and wavelengths. Their bias is not unreasonable, since the French mathematician Fourier showed that any periodic wave with frequency  $f$  can be constructed as a superposition of sine waves with frequencies  $f, 2f, 3f, \dots$ . In this sense, sine waves are the basic, pure building blocks of all waves. (Fourier’s result so surprised the mathematical community of France that he was ridiculed the first time he publicly presented his theorem.)

However, what definition to use is a matter of utility. Our sense of hearing perceives any two sounds having the same period as possessing the same pitch, regardless of whether they are sine waves or not. This is undoubtedly because our ear-brain system evolved to be able to interpret human speech and animal noises, which are periodic but not sinusoidal. Our eyes, on the other hand, judge a color as pure (belonging to the rainbow set of colors) only if it is a sine wave.

### Discussion Question

**A** Suppose we superimpose two sine waves with equal amplitudes but slightly different frequencies, as shown in the figure. What will the superposition look like? What would this sound like if they were sound waves?

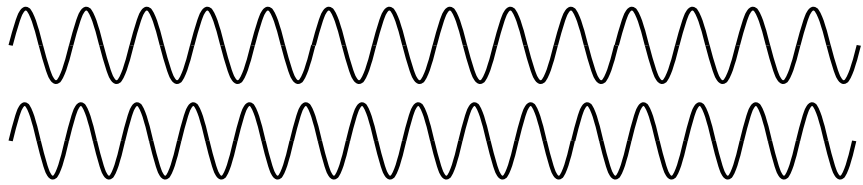



### 3.5 The Doppler Effect

Figure v shows the wave pattern made by the tip of a vibrating rod which is moving across the water. If the rod had been vibrating in one place, we would have seen the familiar pattern of concentric circles, all centered on the same point. But since the source of the waves is moving, the wavelength is shortened on one side and lengthened on the other. This is known as the Doppler effect.

Note that the velocity of the waves is a fixed property of the medium, so for example the forward-going waves do not get an extra boost in speed as would a material object like a bullet being shot forward from an airplane.

We can also infer a change in frequency. Since the velocity is constant, the equation  $v = f\lambda$  tells us that the change in wavelength must be matched by an opposite change in frequency: higher frequency for the waves emitted forward, and lower for the ones emitted backward. The frequency Doppler effect is the reason for the familiar dropping-pitch sound of a race car going by. As the car approaches us, we hear a higher pitch, but after it passes us we hear a frequency that is lower than normal.

The Doppler effect will also occur if the observer is moving but the source is stationary. For instance, an observer moving toward a stationary source will perceive one crest of the wave, and will then be surrounded by the next crest sooner than she otherwise would have, because she has moved toward it and hastened her encounter with it. Roughly speaking, the Doppler effect depends only the relative motion of the source and the observer, not on their absolute state of motion (which is not a well-defined notion in physics) or on their velocity relative to the medium.

Restricting ourselves to the case of a moving source, and to waves emitted either directly along or directly against the direction of motion, we can easily calculate the wavelength, or equivalently the frequency, of the Doppler-shifted waves. Let  $v$  be the velocity of the waves, and  $v_s$  the velocity of the source. The wavelength of the forward-emitted waves is shortened by an amount  $v_s T$  equal to the distance traveled by the source over the course of one period. Using the definition  $f = 1/T$  and the equation  $v = f\lambda$ , we find for the wavelength of the Doppler-shifted wave the equation

$$\lambda' = \left(1 - \frac{v_s}{v}\right) \lambda \quad .$$

A similar equation can be used for the backward-emitted waves, but with a plus sign rather than a minus sign.

---

*Doppler-shifted sound from a race car* *example 6*

▷ If a race car moves at a velocity of 50 m/s, and the velocity of sound is 340 m/s, by what percentage are the wavelength and frequency of its sound waves shifted for an observer lying along its line of motion?

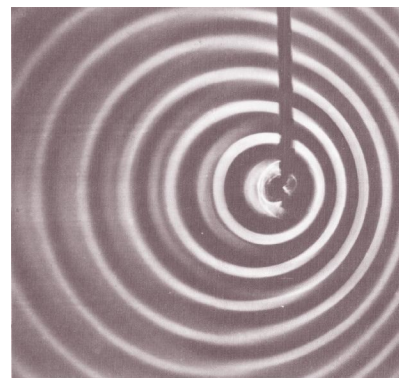

v / The pattern of waves made by a point source moving to the right across the water. Note the shorter wavelength of the forward-emitted waves and the longer wavelength of the backward-going ones.

▷ For an observer whom the car is approaching, we find

$$1 - \frac{v_s}{v} = 0.85 \quad ,$$

so the shift in wavelength is 15%. Since the frequency is inversely proportional to the wavelength for a fixed value of the speed of sound, the frequency is shifted upward by

$$1/0.85 = 1.18,$$

i.e., a change of 18%. (For velocities that are small compared to the wave velocities, the Doppler shifts of the wavelength and frequency are about the same.)

---

*Doppler shift of the light emitted by a race car* *example 7*

▷ What is the percent shift in the wavelength of the light waves emitted by a race car's headlights?

▷ Looking up the speed of light in the front of the book,  $v = 3.0 \times 10^8$  m/s, we find

$$1 - \frac{v_s}{v} = 0.99999983 \quad ,$$

i.e., the percentage shift is only 0.000017%.

The second example shows that under ordinary earthbound circumstances, Doppler shifts of light are negligible because ordinary things go so much slower than the speed of light. It's a different story, however, when it comes to stars and galaxies, and this leads us to a story that has profound implications for our understanding of the origin of the universe.

---

*Doppler radar* *example 8*

The first use of radar was by Britain during World War II: antennas on the ground sent radio waves up into the sky, and detected the echoes when the waves were reflected from German planes. Later, air forces wanted to mount radar antennas on airplanes, but then there was a problem, because if an airplane wanted to detect another airplane at a lower altitude, it would have to aim its radio waves downward, and then it would get echoes from the ground. The solution was the invention of Doppler radar, in which echoes from the ground were differentiated from echoes from other aircraft according to their Doppler shifts. A similar technology is used by meteorologists to map out rainclouds without being swamped by reflections from the ground, trees, and buildings.

---

**Optional topic: Doppler shifts of light**

If Doppler shifts depend only on the relative motion of the source and receiver, then there is no way for a person moving with the source and another person moving with the receiver to determine who is moving and who isn't. Either can blame the Doppler shift entirely on the other's motion and claim to be at rest herself. This is entirely in agreement with the principle stated originally by Galileo that all motion is relative.

On the other hand, a careful analysis of the Doppler shifts of water or sound waves shows that it is only approximately true, at low speeds, that the shifts just depend on the relative motion of the source and observer. For instance, it is possible for a jet plane to keep up with its own sound waves, so that the sound waves appear to stand still to the pilot

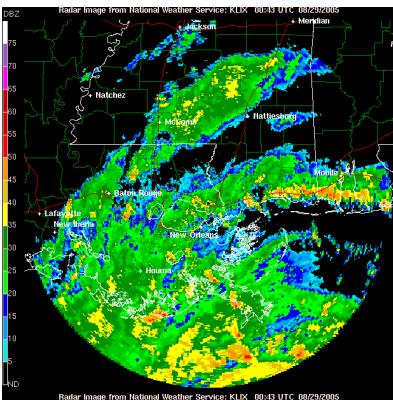

w / Example 8. A Doppler radar image of Hurricane Katrina, in 2005.

of the plane. The pilot then knows she is moving at exactly the speed of sound. The reason this doesn't disprove the relativity of motion is that the pilot is not really determining her absolute motion but rather her motion relative to the air, which is the medium of the sound waves.

Einstein realized that this solved the problem for sound or water waves, but would not salvage the principle of relative motion in the case of light waves, since light is not a vibration of any physical medium such as water or air. Beginning by imagining what a beam of light would look like to a person riding a motorcycle alongside it, Einstein eventually came up with a radical new way of describing the universe, in which space and time are distorted as measured by observers in different states of motion. As a consequence of this Theory of Relativity, he showed that light waves would have Doppler shifts that would exactly, not just approximately, depend only on the relative motion of the source and receiver.

## The Big Bang

As soon as astronomers began looking at the sky through telescopes, they began noticing certain objects that looked like clouds in deep space. The fact that they looked the same night after night meant that they were beyond the earth's atmosphere. Not knowing what they really were, but wanting to sound official, they called them "nebulae," a Latin word meaning "clouds" but sounding more impressive. In the early 20th century, astronomers realized that although some really were clouds of gas (e.g., the middle "star" of Orion's sword, which is visibly fuzzy even to the naked eye when conditions are good), others were what we now call galaxies: virtual island universes consisting of trillions of stars (for example the Andromeda Galaxy, which is visible as a fuzzy patch through binoculars). Three hundred years after Galileo had resolved the Milky Way into individual stars through his telescope, astronomers realized that the universe is made of galaxies of stars, and the Milky Way is simply the visible part of the flat disk of our own galaxy, seen from inside.

This opened up the scientific study of cosmology, the structure and history of the universe as a whole, a field that had not been seriously attacked since the days of Newton. Newton had realized that if gravity was always attractive, never repulsive, the universe would have a tendency to collapse. His solution to the problem was to posit a universe that was infinite and uniformly populated with matter, so that it would have no geometrical center. The gravitational forces in such a universe would always tend to cancel out by symmetry, so there would be no collapse. By the 20th century, the belief in an unchanging and infinite universe had become conventional wisdom in science, partly as a reaction against the time that had been wasted trying to find explanations of ancient geological phenomena based on catastrophes suggested by biblical events like Noah's flood.

In the 1920's astronomer Edwin Hubble began studying the



x / The galaxy M51. Under high magnification, the milky clouds reveal themselves to be composed of trillions of stars.

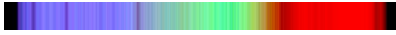

y / How do astronomers know what mixture of wavelengths a star emitted originally, so that they can tell how much the Doppler shift was? This image (obtained by the author with equipment costing about \$5, and no telescope) shows the mixture of colors emitted by the star Sirius. (If you have the book in black and white, blue is on the left and red on the right.) The star appears white or bluish-white to the eye, but any light looks white if it contains roughly an equal mixture of the rainbow colors, i.e., of all the pure sinusoidal waves with wavelengths lying in the visible range. Note the black “gap teeth.” These are the fingerprint of hydrogen in the outer atmosphere of Sirius. These wavelengths are selectively absorbed by hydrogen. Sirius is in our own galaxy, but similar stars in other galaxies would have the whole pattern shifted toward the red end, indicating they are moving away from us.



z / The telescope at Mount Wilson used by Hubble.

Doppler shifts of the light emitted by galaxies. A former college football player with a serious nicotine addiction, Hubble did not set out to change our image of the beginning of the universe. His autobiography seldom even mentions the cosmological discovery for which he is now remembered. When astronomers began to study the Doppler shifts of galaxies, they expected that each galaxy’s direction and velocity of motion would be essentially random. Some would be approaching us, and their light would therefore be Doppler-shifted to the blue end of the spectrum, while an equal number would be expected to have red shifts. What Hubble discovered instead was that except for a few very nearby ones, all the galaxies had red shifts, indicating that they were receding from us at a hefty fraction of the speed of light. Not only that, but the ones farther away were receding more quickly. The speeds were directly proportional to their distance from us.

Did this mean that the earth (or at least our galaxy) was the center of the universe? No, because Doppler shifts of light only depend on the relative motion of the source and the observer. If we see a distant galaxy moving away from us at 10% of the speed of light, we can be assured that the astronomers who live in that galaxy will see ours receding from them at the same speed in the opposite direction. The whole universe can be envisioned as a rising loaf of raisin bread. As the bread expands, there is more and more space between the raisins. The farther apart two raisins are, the greater the speed with which they move apart.

Extrapolating backward in time using the known laws of physics, the universe must have been denser and denser at earlier and earlier times. At some point, it must have been extremely dense and hot, and we can even detect the radiation from this early fireball, in the form of microwave radiation that permeates space. The phrase Big Bang was originally coined by the doubters of the theory to make it sound ridiculous, but it stuck, and today essentially all astronomers accept the Big Bang theory based on the very direct evidence of the red shifts and the cosmic microwave background radiation.

### What the big bang is not

Finally it should be noted what the Big Bang theory is not. It is not an explanation of *why* the universe exists. Such questions belong to the realm of religion, not science. Science can find ever simpler and ever more fundamental explanations for a variety of phenomena, but ultimately science takes the universe as it is according to observations.

Furthermore, there is an unfortunate tendency, even among many scientists, to speak of the Big Bang theory as a description of the very first event in the universe, which caused everything after it. Although it is true that time may have had a beginning (Einstein’s theory of general relativity admits such a possibility), the methods

of science can only work within a certain range of conditions such as temperature and density. Beyond a temperature of about  $10^9$  degrees C, the random thermal motion of subatomic particles becomes so rapid that its velocity is comparable to the speed of light. Early enough in the history of the universe, when these temperatures existed, Newtonian physics becomes less accurate, and we must describe nature using the more general description given by Einstein's theory of relativity, which encompasses Newtonian physics as a special case. At even higher temperatures, beyond about  $10^{33}$  degrees, physicists know that Einstein's theory as well begins to fall apart, but we don't know how to construct the even more general theory of nature that would work at those temperatures. No matter how far physics progresses, we will never be able to describe nature at infinitely high temperatures, since there is a limit to the temperatures we can explore by experiment and observation in order to guide us to the right theory. We are confident that we understand the basic physics involved in the evolution of the universe starting a few minutes after the Big Bang, and we may be able to push back to milliseconds or microseconds after it, but we cannot use the methods of science to deal with the beginning of time itself.

### Discussion Questions

- A** If an airplane travels at exactly the speed of sound, what would be the wavelength of the forward-emitted part of the sound waves it emitted? How should this be interpreted, and what would actually happen? What happens if it's going faster than the speed of sound? Can you use this to explain what you see in figures aa and ab?
- B** If bullets go slower than the speed of sound, why can a supersonic fighter plane catch up to its own sound, but not to its own bullets?
- C** If someone inside a plane is talking to you, should their speech be Doppler shifted?

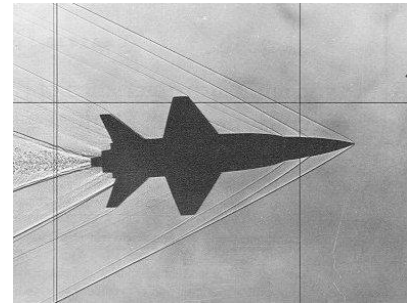

aa / Shock waves from by the X-15 rocket plane, flying at 3.5 times the speed of sound.



ab / This fighter jet has just accelerated past the speed of sound. The sudden decompression of the air causes water droplets to condense, forming a cloud.

## Summary

### Selected Vocabulary

superposition . . .	the adding together of waves that overlap with each other
medium . . . . .	a physical substance whose vibrations constitute a wave
wavelength . . . .	the distance in space between repetitions of a periodic wave
Doppler effect . . .	the change in a wave's frequency and wavelength due to the motion of the source or the observer or both

### Notation

$\lambda$ . . . . .	wavelength (Greek letter lambda)
---------------------	----------------------------------

### Summary

Wave motion differs in three important ways from the motion of material objects:

(1) Waves obey the principle of superposition. When two waves collide, they simply add together.

(2) The medium is not transported along with the wave. The motion of any given point in the medium is a vibration about its equilibrium location, not a steady forward motion.

(3) The velocity of a wave depends on the medium, not on the amount of energy in the wave. (For some types of waves, notably water waves, the velocity may also depend on the shape of the wave.)

Sound waves consist of increases and decreases (typically very small ones) in the density of the air. Light is a wave, but it is a vibration of electric and magnetic fields, not of any physical medium. Light can travel through a vacuum.

A periodic wave is one that creates a periodic motion in a receiver as it passes it. Such a wave has a well-defined period and frequency, and it will also have a wavelength, which is the distance in space between repetitions of the wave pattern. The velocity, frequency, and wavelength of a periodic wave are related by the equation

$$v = f\lambda.$$

A wave emitted by a moving source will be shifted in wavelength and frequency. The shifted wavelength is given by the equation

$$\lambda' = \left(1 - \frac{v_s}{v}\right) \lambda \quad ,$$

where  $v$  is the velocity of the waves and  $v_s$  is the velocity of the source, taken to be positive or negative so as to produce a Doppler-lengthened wavelength if the source is receding and a Doppler-shortened one if it approaches. A similar shift occurs if the observer

is moving, and in general the Doppler shift depends approximately only on the relative motion of the source and observer if their velocities are both small compared to the waves' velocity. (This is not just approximately but exactly true for light waves, and this fact forms the basis of Einstein's Theory of Relativity.)

## Problems

### Key

- ✓ A computerized answer check is available online.
- ∫ A problem that requires calculus.
- ★ A difficult problem.

1 The following is a graph of the height of a water wave as a function of *position*, at a certain moment in time.



Trace this graph onto another piece of paper, and then sketch below it the corresponding graphs that would be obtained if

- (a) the amplitude and frequency were doubled while the velocity remained the same;
- (b) the frequency and velocity were both doubled while the amplitude remained unchanged;
- (c) the wavelength and amplitude were reduced by a factor of three while the velocity was doubled.

[Problem by Arnold Arons.]

2 (a) The graph shows the height of a water wave pulse as a function of position. Draw a graph of height as a function of time for a specific point on the water. Assume the pulse is traveling to the right.

- (b) Repeat part a, but assume the pulse is traveling to the left.
- (c) Now assume the original graph was of height as a function of time, and draw a graph of height as a function of position, assuming the pulse is traveling to the right.
- (d) Repeat part c, but assume the pulse is traveling to the left.

[Problem by Arnold Arons.]

3 The figure shows one wavelength of a steady sinusoidal wave traveling to the right along a string. Define a coordinate system in which the positive  $x$  axis points to the right and the positive  $y$  axis up, such that the flattened string would have  $y = 0$ . Copy the figure, and label with  $y = 0$  all the appropriate parts of the string. Similarly, label with  $v = 0$  all parts of the string whose velocities are zero, and with  $a = 0$  all parts whose accelerations are zero. There is more than one point whose velocity is of the greatest magnitude. Pick one of these, and indicate the direction of its velocity vector. Do the same for a point having the maximum magnitude of acceleration.



Problem 2.



Problem 3.



[Problem by Arnold Arons.]

**4** Find an equation for the relationship between the Doppler-shifted frequency of a wave and the frequency of the original wave, for the case of a stationary observer and a source moving directly toward or away from the observer.

**5** Suggest a quantitative experiment to look for any deviation from the principle of superposition for surface waves in water. Make it simple and practical.

**6** The musical note middle  $C$  has a frequency of 262 Hz. What are its period and wavelength? ✓

**7** Singing that is off-pitch by more than about 1% sounds bad. How fast would a singer have to be moving relative to the rest of a band to make this much of a change in pitch due to the Doppler effect? ✓

**8** In section 3.2, we saw that the speed of waves on a string depends on the ratio of  $T/\mu$ , i.e., the speed of the wave is greater if the string is under more tension, and less if it has more inertia. This is true in general: the speed of a mechanical wave always depends on the medium's inertia in relation to the restoring force (tension, stiffness, resistance to compression,...) Based on these ideas, explain why the speed of sound in a gas depends strongly on temperature, while the speed of sounds in liquids and solids does not.





A cross-sectional view of a human body, showing the vocal tract.

## Chapter 4

# Bounded Waves

Speech is what separates humans most decisively from animals. No other species can master syntax, and even though chimpanzees can learn a vocabulary of hand signs, there is an unmistakable difference between a human infant and a baby chimp: starting from birth, the human experiments with the production of complex speech sounds.

Since speech sounds are instinctive for us, we seldom think about them consciously. How do we do control sound waves so skillfully? Mostly we do it by changing the shape of a connected set of hollow cavities in our chest, throat, and head. Somehow by moving the boundaries of this space in and out, we can produce all the vowel sounds. Up until now, we have been studying only those properties of waves that can be understood as if they existed in an infinite, open space with no boundaries. In this chapter we address what happens when a wave is confined within a certain space, or when a wave pattern encounters the boundary between two different media, such as when a light wave moving through air encounters a glass

windowpane.

## 4.1 Reflection, Transmission, and Absorption

### Reflection and transmission

Sound waves can echo back from a cliff, and light waves are reflected from the surface of a pond. We use the word reflection, normally applied only to light waves in ordinary speech, to describe any such case of a wave rebounding from a barrier. Figure a shows a circular water wave being reflected from a straight wall. In this chapter, we will concentrate mainly on reflection of waves that move in one dimension, as in figure b.

Wave reflection does not surprise us. After all, a material object such as a rubber ball would bounce back in the same way. But waves are not objects, and there are some surprises in store.

First, only part of the wave is usually reflected. Looking out through a window, we see light waves that passed through it, but a person standing outside would also be able to see her reflection in the glass. A light wave that strikes the glass is partly *reflected* and partly *transmitted* (passed) by the glass. The energy of the original wave is split between the two. This is different from the behavior of the rubber ball, which must go one way or the other, not both.

Second, consider what you see if you are swimming underwater and you look up at the surface. You see your own reflection. This is utterly counterintuitive, since we would expect the light waves to burst forth to freedom in the wide-open air. A material projectile shot up toward the surface would never rebound from the water-air boundary!

What is it about the difference between two media that causes waves to be partly reflected at the boundary between them? Is it their density? Their chemical composition? Ultimately all that matters is the speed of the wave in the two media. *A wave is partially reflected and partially transmitted at the boundary between media in which it has different speeds.* For example, the speed of light waves in window glass is about 30% less than in air, which explains why windows always make reflections. Figures c/1 and 2 show examples of wave pulses being reflected at the boundary between two coil springs of different weights, in which the wave speed is different.

Reflections such as a and b, where a wave encounters a massive fixed object, can usually be understood on the same basis as cases like c/1 and 2 later in his section, where two media meet. Example b, for instance, is like a more extreme version of example c/1. If the heavy coil spring in c/1 was made heavier and heavier, it would end up acting like the fixed wall to which the light spring in b has been attached.

#### *self-check A*

In figure b, the reflected pulse is upside-down, but its depth is just as big as the original pulse's height. How does the energy of the reflected



a / Circular water waves are reflected from a boundary on the left.

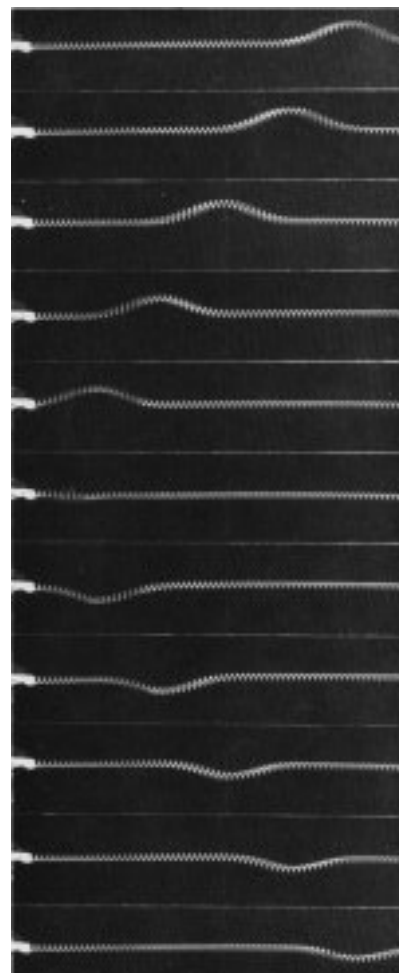

b / A wave on a spring, initially traveling to the left, is reflected from the fixed end.

pulse compare with that of the original?

▷ Answer, p. 101

*Fish have internal ears.*

*example 1*

Why don't fish have ear-holes? The speed of sound waves in a fish's body is not much different from their speed in water, so sound waves are not strongly reflected from a fish's skin. They pass right through its body, so fish can have internal ears.

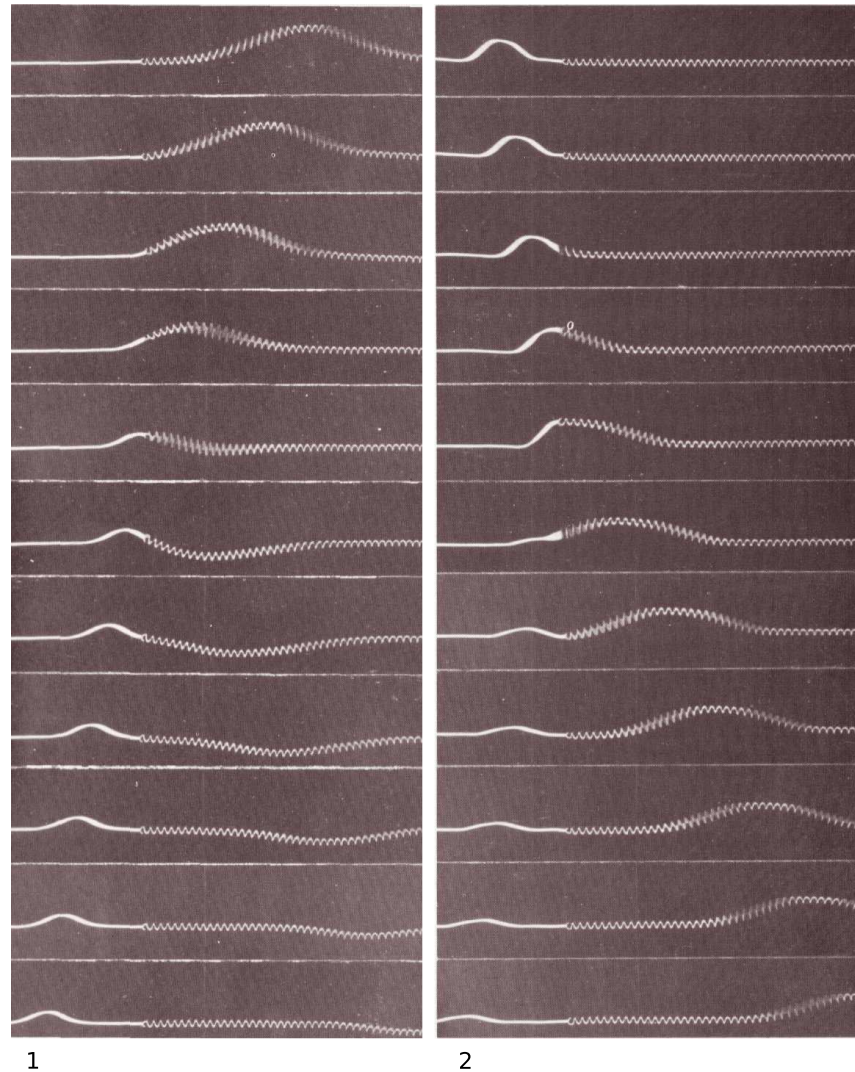

c / 1. A wave in the lighter spring, where the wave speed is greater, travels to the left and is then partly reflected and partly transmitted at the boundary with the heavier coil spring, which has a lower wave speed. The reflection is inverted. 2. A wave moving to the right in the heavier spring is partly reflected at the boundary with the lighter spring. The reflection is uninverted.

*Whale songs traveling long distances*

*example 2*

Sound waves travel at drastically different speeds through rock, water, and air. Whale songs are thus strongly reflected at both the bottom and

the surface. The sound waves can travel hundreds of miles, bouncing repeatedly between the bottom and the surface, and still be detectable. Sadly, noise pollution from ships has nearly shut down this cetacean version of the internet.

*Long-distance radio communication.* *example 3*  
 Radio communication can occur between stations on opposite sides of the planet. The mechanism is similar to the one explained in example 2, but the three media involved are the earth, the atmosphere, and the ionosphere.

*self-check B*

Sonar is a method for ships and submarines to detect each other by producing sound waves and listening for echoes. What properties would an underwater object have to have in order to be invisible to sonar? ▷

Answer, p. 101

The use of the word “reflection” naturally brings to mind the creation of an image by a mirror, but this might be confusing, because we do not normally refer to “reflection” when we look at surfaces that are not shiny. Nevertheless, reflection is how we see the surfaces of all objects, not just polished ones. When we look at a sidewalk, for example, we are actually seeing the reflecting of the sun from the concrete. The reason we don’t see an image of the sun at our feet is simply that the rough surface blurs the image so drastically.

**Inverted and uninverted reflections**

Notice how the pulse reflected back to the right in example c/1 comes back upside-down, whereas the one reflected back to the left in 2 returns in its original upright form. This is true for other waves as well. In general, there are two possible types of reflections, a reflection back into a faster medium and a reflection back into a slower medium. One type will always be an inverting reflection and one noninverting.

It’s important to realize that when we discuss inverted and uninverted reflections on a string, we are talking about whether the wave is flipped across the direction of motion (i.e., upside-down in these drawings). The reflected pulse will always be reversed front to back, as shown in figure d. This is because it is traveling in the other direction. The leading edge of the pulse is what gets reflected first, so it is still ahead when it starts back to the left — it’s just that “ahead” is now in the opposite direction.

**Absorption**

So far we have tacitly assumed that wave energy remains as wave energy, and is not converted to any other form. If this was true, then the world would become more and more full of sound waves, which could never escape into the vacuum of outer space. In reality, any mechanical wave consists of a traveling pattern of vibrations of some physical medium, and vibrations of matter always produce heat, as

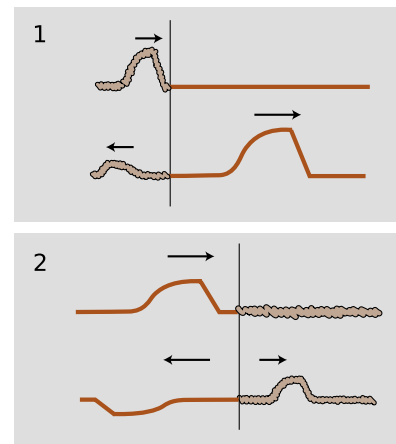

d / 1. An uninverted reflection. The reflected pulse is reversed front to back, but is not upside-down. 2. An inverted reflection. The reflected pulse is reversed both front to back and top to bottom.

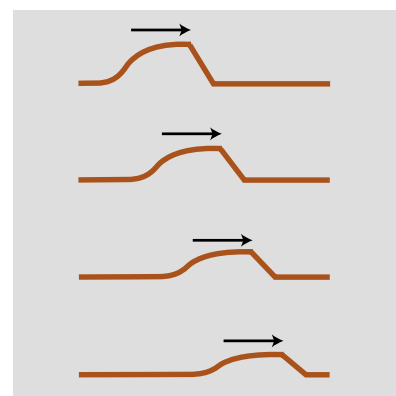

e / A pulse traveling through a highly absorptive medium.

when you bend a coat-hangar back and forth and it becomes hot. We can thus expect that in mechanical waves such as water waves, sound waves, or waves on a string, the wave energy will gradually be converted into heat. This is referred to as *absorption*.

The wave suffers a decrease in amplitude, as shown in figure e. The decrease in amplitude amounts to the same fractional change for each unit of distance covered. For example, if a wave decreases from amplitude 2 to amplitude 1 over a distance of 1 meter, then after traveling another meter it will have an amplitude of  $1/2$ . That is, the reduction in amplitude is exponential. This can be proven as follows. By the principle of superposition, we know that a wave of amplitude 2 must behave like the superposition of two identical waves of amplitude 1. If a single amplitude-1 wave would die down to amplitude  $1/2$  over a certain distance, then two amplitude-1 waves superposed on top of one another to make amplitude  $1 + 1 = 2$  must die down to amplitude  $1/2 + 1/2 = 1$  over the same distance.

#### *self-check C*

As a wave undergoes absorption, it loses energy. Does this mean that it slows down? ▷ Answer, p. 101

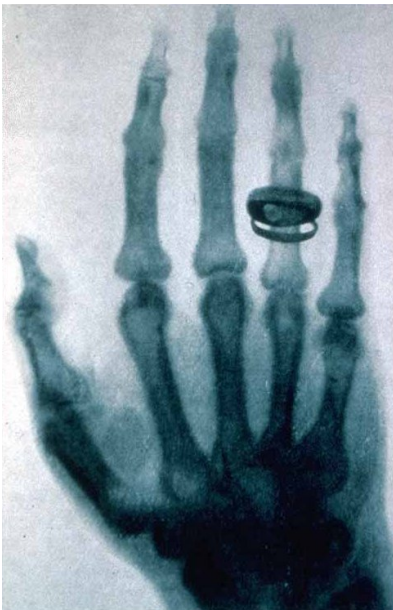

f / X-rays are light waves with a very high frequency. They are absorbed strongly by bones, but weakly by flesh.

In many cases, this frictional heating effect is quite weak. Sound waves in air, for instance, dissipate into heat extremely slowly, and the sound of church music in a cathedral may reverberate for as much as 3 or 4 seconds before it becomes inaudible. During this time it has traveled over a kilometer! Even this very gradual dissipation of energy occurs mostly as heating of the church's walls and by the leaking of sound to the outside (where it will eventually end up as heat). Under the right conditions (humid air and low frequency), a sound wave in a straight pipe could theoretically travel hundreds of kilometers before being noticeable attenuated.

In general, the absorption of mechanical waves depends a great deal on the chemical composition and microscopic structure of the medium. Ripples on the surface of antifreeze, for instance, die out extremely rapidly compared to ripples on water. For sound waves and surface waves in liquids and gases, what matters is the viscosity of the substance, i.e., whether it flows easily like water or mercury or more sluggishly like molasses or antifreeze. This explains why our intuitive expectation of strong absorption of sound in water is incorrect. Water is a very weak absorber of sound (viz. whale songs and sonar), and our incorrect intuition arises from focusing on the wrong property of the substance: water's high density, which is irrelevant, rather than its low viscosity, which is what matters.

Light is an interesting case, since although it can travel through matter, it is not itself a vibration of any material substance. Thus we can look at the star Sirius,  $10^{14}$  km away from us, and be assured that none of its light was absorbed in the vacuum of outer space during its 9-year journey to us. The Hubble Space Telescope



routinely observes light that has been on its way to us since the early history of the universe, billions of years ago. Of course the energy of light can be dissipated if it does pass through matter (and the light from distant galaxies is often absorbed if there happen to be clouds of gas or dust in between).

---

*Soundproofing*

*example 4*

Typical amateur musicians setting out to soundproof their garages tend to think that they should simply cover the walls with the densest possible substance. In fact, sound is not absorbed very strongly even by passing through several inches of wood. A better strategy for soundproofing is to create a sandwich of alternating layers of materials in which the speed of sound is very different, to encourage reflection.

The classic design is alternating layers of fiberglass and plywood. The speed of sound in plywood is very high, due to its stiffness, while its speed in fiberglass is essentially the same as its speed in air. Both materials are fairly good sound absorbers, but sound waves passing through a few inches of them are still not going to be absorbed sufficiently. The point of combining them is that a sound wave that tries to get out will be strongly reflected at each of the fiberglass-plywood boundaries, and will bounce back and forth many times like a ping pong ball. Due to all the back-and-forth motion, the sound may end up traveling a total distance equal to ten times the actual thickness of the soundproofing before it escapes. This is the equivalent of having ten times the thickness of sound-absorbing material.

---

*The swim bladder*

*example 5*

The swim bladder of a fish, which was first discussed in homework problem 2 in chapter 2, is often located right next to the fish's ear. As discussed in example 1 on page 78, the fish's body is nearly transparent to sound, so it's actually difficult to get any of the sound wave energy to deposit itself in the fish so that the fish can hear it! The physics here is almost exactly the same as the physics of example 4 above, with the gas-filled swim bladder playing the role of the low-density material.

---

*Radio transmission*

*example 6*

A radio transmitting station, such as a commercial station or an amateur "ham" radio station, must have a length of wire or cable connecting the amplifier to the antenna. The cable and the antenna act as two different media for radio waves, and there will therefore be partial reflection of the waves as they come from the cable to the antenna. If the waves bounce back and forth many times between the amplifier and the antenna, a great deal of their energy will be absorbed. There are two ways to attack the problem. One possibility is to design the antenna so that the speed of the waves in it is as close as possible to the speed of the waves in the cable; this minimizes the amount of reflection. The other method is to connect the amplifier to the antenna using a type of wire or cable that does not strongly absorb the waves. Partial reflection then becomes irrelevant, since all the wave energy will eventually exit through the antenna.

### Discussion Question

**A** A sound wave that underwent a pressure-inverting reflection would have its compressions converted to expansions and vice versa. How

would its energy and frequency compare with those of the original sound? Would it sound any different? What happens if you swap the two wires where they connect to a stereo speaker, resulting in waves that vibrate in the opposite way?

## 4.2 ★ Quantitative Treatment of Reflection

In this optional section we analyze the reasons why reflections occur at a speed-changing boundary, predict quantitatively the intensities of reflection and transmission, and discuss how to predict for any type of wave which reflections are inverting and which are noninverting. The gory details are likely to be of interest mainly to students with concentrations in the physical sciences, but all readers are encouraged at least to skim the first two subsections for physical insight.

### Why reflection occurs

To understand the fundamental reasons for what does occur at the boundary between media, let's first discuss what doesn't happen. For the sake of concreteness, consider a sinusoidal wave on a string. If the wave progresses from a heavier portion of the string, in which its velocity is low, to a lighter-weight part, in which it is high, then the equation  $v = f\lambda$  tells us that it must change its frequency, or its wavelength, or both. If only the frequency changed, then the parts of the wave in the two different portions of the string would quickly get out of step with each other, producing a discontinuity in the wave, g/1. This is unphysical, so we know that the wavelength must change while the frequency remains constant, 2.

But there is still something unphysical about figure 2. The sudden change in the shape of the wave has resulted in a sharp kink at the boundary. This can't really happen, because the medium tends to accelerate in such a way as to eliminate curvature. A sharp kink corresponds to an infinite curvature at one point, which would produce an infinite acceleration, which would not be consistent with the smooth pattern of wave motion envisioned in figure 2. Waves can have kinks, but not stationary kinks.

We conclude that without positing partial reflection of the wave, we cannot simultaneously satisfy the requirements of (1) continuity of the wave, and (2) no sudden changes in the slope of the wave. (The student who has studied calculus will recognize this as amounting to an assumption that both the wave and its derivative are continuous functions.)

Does this amount to a proof that reflection occurs? Not quite. We have only proven that certain types of wave motion are not valid solutions. In the following subsection, we prove that a valid solution can always be found in which a reflection occurs. Now in physics, we normally assume (but seldom prove formally) that the equations of motion have a unique solution, since otherwise a given set of initial conditions could lead to different behavior later on, but the Newtonian universe is supposed to be deterministic. Since the solution must be unique, and we derive below a valid solution involving a reflected pulse, we will have ended up with what amounts

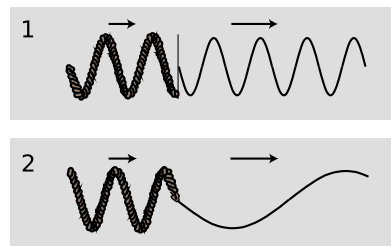

g / 1. A change in frequency without a change in wavelength would produce a discontinuity in the wave. 2. A simple change in wavelength without a reflection would result in a sharp kink in the wave.

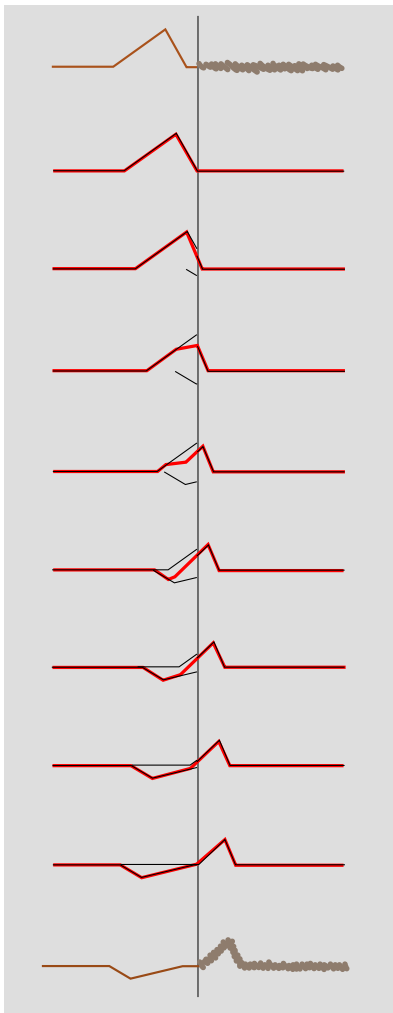

h/A pulse being partially reflected and partially transmitted at the boundary between two strings in which the speed of waves is different. The top drawing shows the pulse heading to the right, toward the heavier string. For clarity, all but the first and last drawings are schematic. Once the reflected pulse begins to emerge from the boundary, it adds together with the trailing parts of the incident pulse. Their sum, shown as a wider line, is what is actually observed.

to a proof of reflection.

### Intensity of reflection

We will now show, in the case of waves on a string, that it is possible to satisfy the physical requirements given above by constructing a reflected wave, and as a bonus this will produce an equation for the proportions of reflection and transmission and a prediction as to which conditions will lead to inverted and which to uninverted reflection. We assume only that the principle of superposition holds, which is a good approximation for waves on a string of sufficiently small amplitude.

Let the unknown amplitudes of the reflected and transmitted waves be  $R$  and  $T$ , respectively. An inverted reflection would be represented by a negative value of  $R$ . We can without loss of generality take the incident (original) wave to have unit amplitude. Superposition tells us that if, for instance, the incident wave had double this amplitude, we could immediately find a corresponding solution simply by doubling  $R$  and  $T$ .

Just to the left of the boundary, the height of the wave is given by the height 1 of the incident wave, plus the height  $R$  of the part of the reflected wave that has just been created and begun heading back, for a total height of  $1 + R$ . On the right side immediately next to the boundary, the transmitted wave has a height  $T$ . To avoid a discontinuity, we must have

$$1 + R = T \quad .$$

Next we turn to the requirement of equal slopes on both sides of the boundary. Let the slope of the incoming wave be  $s$  immediately to the left of the junction. If the wave was 100% reflected, and without inversion, then the slope of the reflected wave would be  $-s$ , since the wave has been reversed in direction. In general, the slope of the reflected wave equals  $-sR$ , and the slopes of the superposed waves on the left side add up to  $s - sR$ . On the right, the slope depends on the amplitude,  $T$ , but is also changed by the stretching or compression of the wave due to the change in speed. If, for example, the wave speed is twice as great on the right side, then the slope is cut in half by this effect. The slope on the right is therefore  $s(v_1/v_2)T$ , where  $v_1$  is the velocity in the original medium and  $v_2$  the velocity in the new medium. Equality of slopes gives  $s - sR = s(v_1/v_2)T$ , or

$$1 - R = \frac{v_1}{v_2}T \quad .$$

Solving the two equations for the unknowns  $R$  and  $T$  gives

$$R = \frac{v_2 - v_1}{v_2 + v_1} \quad \text{and} \quad T = \frac{2v_2}{v_2 + v_1} \quad .$$

The first equation shows that there is no reflection unless the two wave speeds are different, and that the reflection is inverted in reflection back into a fast medium.

The energies of the transmitted and reflected waves always add up to the same as the energy of the original wave. There is never any abrupt loss (or gain) in energy when a wave crosses a boundary. (Conversion of wave energy to heat occurs for many types of waves, but it occurs throughout the medium.) The equation for  $T$ , surprisingly, allows the amplitude of the transmitted wave to be greater than 1, i.e., greater than that of the incident wave. This does not violate conservation of energy, because this occurs when the second string is less massive, reducing its kinetic energy, and the transmitted pulse is broader and less strongly curved, which lessens its potential energy.

### Inverted and uninverted reflections in general

For waves on a string, reflections back into a faster medium are inverted, while those back into a slower medium are uninverted. Is this true for all types of waves? The rather subtle answer is that it depends on what property of the wave you are discussing.

Let's start by considering wave disturbances of freeway traffic. Anyone who has driven frequently on crowded freeways has observed the phenomenon in which one driver taps the brakes, starting a chain reaction that travels backward down the freeway as each person in turn exercises caution in order to avoid rear-ending anyone. The reason why this type of wave is relevant is that it gives a simple, easily visualized example of our description of a wave depends on which aspect of the wave we have in mind. In steadily flowing freeway traffic, both the density of cars and their velocity are constant all along the road. Since there is no disturbance in this pattern of constant velocity and density, we say that there is no wave. Now if a wave is touched off by a person tapping the brakes, we can either describe it as a region of high density or as a region of decreasing velocity.

The freeway traffic wave is in fact a good model of a sound wave, and a sound wave can likewise be described either by the density (or pressure) of the air or by its speed. Likewise many other types of waves can be described by either of two functions, one of which is often the derivative of the other with respect to position.

Now let's consider reflections. If we observe the freeway wave in a mirror, the high-density area will still appear high in density, but velocity in the opposite direction will now be described by a negative number. A person observing the mirror image will draw the same density graph, but the velocity graph will be flipped across the  $x$  axis, and its original region of negative slope will now have positive slope. Although I don't know any physical situation that would

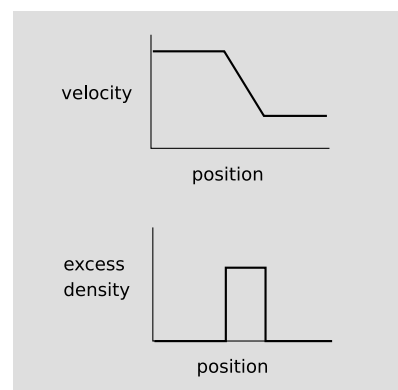

Figure 4.2: A disturbance in freeway traffic.

correspond to the reflection of a traffic wave, we can immediately apply the same reasoning to sound waves, which often do get reflected, and determine that a reflection can either be density-inverting and velocity-noninverting or density-noninverting and velocity-inverting.

This same type of situation will occur over and over as one encounters new types of waves, and to apply the analogy we need only determine which quantities, like velocity, become negated in a mirror image and which, like density, stay the same.

A light wave, for instance consists of a traveling pattern of electric and magnetic fields. All you need to know in order to analyze the reflection of light waves is how electric and magnetic fields behave under reflection; you don't need to know any of the detailed physics of electricity and magnetism. An electric field can be detected, for example, by the way one's hair stands on end. The direction of the hair indicates the direction of the electric field. In a mirror image, the hair points the other way, so the electric field is apparently reversed in a mirror image. The behavior of magnetic fields, however, is a little tricky. The magnetic properties of a bar magnet, for instance, are caused by the aligned rotation of the outermost orbiting electrons of the atoms. In a mirror image, the direction of rotation is reversed, say from clockwise to counterclockwise, and so the magnetic field is reversed twice: once simply because the whole picture is flipped and once because of the reversed rotation of the electrons. In other words, magnetic fields do not reverse themselves in a mirror image. We can thus predict that there will be two possible types of reflection of light waves. In one, the electric field is inverted and the magnetic field uninverted. In the other, the electric field is uninverted and the magnetic field inverted.

### 4.3 Interference Effects

If you look at the front of a pair of high-quality binoculars, you will notice a greenish-blue coating on the lenses. This is advertised as a coating to prevent reflection. Now reflection is clearly undesirable — we want the light to go *in* the binoculars — but so far I've described reflection as an unalterable fact of nature, depending only on the properties of the two wave media. The coating can't change the speed of light in air or in glass, so how can it work? The key is that the coating itself is a wave medium. In other words, we have a three-layer sandwich of materials: air, coating, and glass. We will analyze the way the coating works, not because optical coatings are an important part of your education but because it provides a good example of the general phenomenon of wave interference effects.

There are two different interfaces between media: an air-coating boundary and a coating-glass boundary. Partial reflection and partial transmission will occur at each boundary. For ease of visualization let's start by considering an equivalent system consisting of three dissimilar pieces of string tied together, and a wave pattern consisting initially of a single pulse. Figure k/1 shows the incident pulse moving through the heavy rope, in which its velocity is low. When it encounters the lighter-weight rope in the middle, a faster medium, it is partially reflected and partially transmitted. (The transmitted pulse is bigger, but nevertheless has only part of the original energy.) The pulse transmitted by the first interface is then partially reflected and partially transmitted by the second boundary, 3. In figure 4, two pulses are on the way back out to the left, and a single pulse is heading off to the right. (There is still a weak pulse caught between the two boundaries, and this will rattle back and forth, rapidly getting too weak to detect as it leaks energy to the outside with each partial reflection.)

Note how, of the two reflected pulses in 4, one is inverted and one uninverted. One underwent reflection at the first boundary (a reflection back into a slower medium is uninverted), but the other was reflected at the second boundary (reflection back into a faster medium is inverted).

Now let's imagine what would have happened if the incoming wave pattern had been a long sinusoidal wave train instead of a single pulse. The first two waves to reemerge on the left could be in phase, 1/1, or out of phase, 2, or anywhere in between. The amount of lag between them depends entirely on the width of the middle segment of string. If we choose the width of the middle string segment correctly, then we can arrange for destructive interference to occur, 2, with cancellation resulting in a very weak reflected wave.

This whole analysis applies directly to our original case of optical coatings. Visible light from most sources does consist of a stream of short sinusoidal wave-trains such as the ones drawn above. The only



j / Seen from this angle, the optical coating on the lenses of these binoculars appears purple and green. (The color varies depending on the angle from which the coating is viewed, and the angle varies across the faces of the lenses because of their curvature.)

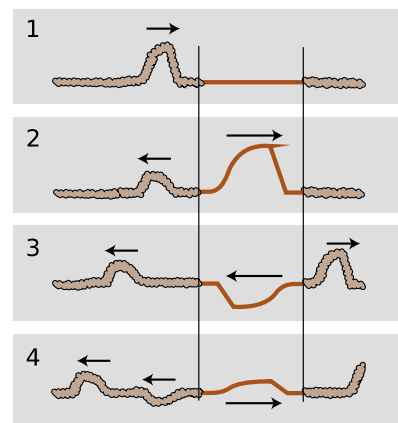

k / A rope consisting of three sections, the middle one being lighter.

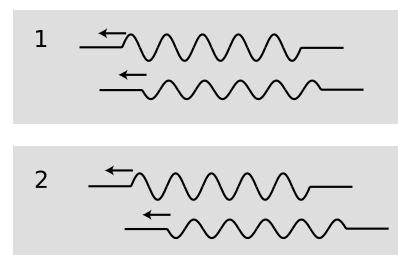

l / Two reflections, are superimposed. One reflection is inverted.

real difference between the waves-on-a-rope example and the case of an optical coating is that the first and third media are air and glass, in which light does not have the same speed. However, the general result is the same as long as the air and the glass have light-wave speeds that either both greater than the coating's or both less than the coating's.

The business of optical coatings turns out to be a very arcane one, with a plethora of trade secrets and “black magic” techniques handed down from master to apprentice. Nevertheless, the ideas you have learned about waves in general are sufficient to allow you to come to some definite conclusions without any further technical knowledge. The self-check and discussion questions will direct you along these lines of thought.

The example of an optical coating was typical of a wide variety of wave interference effects. With a little guidance, you are now ready to figure out for yourself other examples such as the rainbow pattern made by a compact disc, a layer of oil on a puddle, or a soap bubble.



m / A soap bubble displays interference effects.

*self-check D*

1. Color corresponds to wavelength of light waves. Is it possible to choose a thickness for an optical coating that will produce destructive interference for all colors of light?

2. How can you explain the rainbow colors on the soap bubble in figure m? ▷ Answer, p. 101

### Discussion Questions

**A** Is it possible to get *complete* destructive interference in an optical coating, at least for light of one specific wavelength?

**B** Sunlight consists of sinusoidal wave-trains containing on the order of a hundred cycles back-to-back, for a length of something like a tenth of a millimeter. What happens if you try to make an optical coating thicker than this?

**C** Suppose you take two microscope slides and lay one on top of the other so that one of its edges is resting on the corresponding edge of the bottom one. If you insert a sliver of paper or a hair at the opposite end, a wedge-shaped layer of air will exist in the middle, with a thickness that changes gradually from one end to the other. What would you expect to see if the slides were illuminated from above by light of a single color? How would this change if you gradually lifted the lower edge of the top slide until the two slides were finally parallel?

**D** An observation like the one described in the previous discussion question was used by Newton as evidence *against* the wave theory of light! If Newton didn't know about inverting and noninverting reflections, what would have seemed inexplicable to him about the region where the air layer had zero or nearly zero thickness?



## 4.4 Waves Bounded on Both Sides

In the examples discussed in section 4.3, it was theoretically true that a pulse would be trapped permanently in the middle medium, but that pulse was not central to our discussion, and in any case it was weakening severely with each partial reflection. Now consider a guitar string. At its ends it is tied to the body of the instrument itself, and since the body is very massive, the behavior of the waves when they reach the end of the string can be understood in the same way as if the actual guitar string was attached on the ends to strings that were extremely massive. Reflections are most intense when the two media are very dissimilar. Because the wave speed in the body is so radically different from the speed in the string, we should expect nearly 100% reflection.

Although this may seem like a rather bizarre physical model of the actual guitar string, it already tells us something interesting about the behavior of a guitar that we would not otherwise have understood. The body, far from being a passive frame for attaching the strings to, is actually the exit path for the wave energy in the strings. With every reflection, the wave pattern on the string loses a tiny fraction of its energy, which is then conducted through the body and out into the air. (The string has too little cross-section to make sound waves efficiently by itself.) By changing the properties of the body, moreover, we should expect to have an effect on the manner in which sound escapes from the instrument. This is clearly demonstrated by the electric guitar, which has an extremely massive, solid wooden body. Here the dissimilarity between the two wave media is even more pronounced, with the result that wave energy leaks out of the string even more slowly. This is why an electric guitar with no electric pickup can hardly be heard at all, and it is also the reason why notes on an electric guitar can be sustained for longer than notes on an acoustic guitar.

If we initially create a disturbance on a guitar string, how will the reflections behave? In reality, the finger or pick will give the string a triangular shape before letting it go, and we may think of this triangular shape as a very broad “dent” in the string which will spread out in both directions. For simplicity, however, let’s just imagine a wave pattern that initially consists of a single, narrow pulse traveling up the neck, o/1. After reflection from the top end, it is inverted, 3. Now something interesting happens: figure 5 is identical to figure 1. After two reflections, the pulse has been inverted twice and has changed direction twice. It is now back where it started. The motion is periodic. This is why a guitar produces sounds that have a definite sensation of pitch.

### *self-check E*

Notice that from o/1 to o/5, the pulse has passed by every point on the string exactly twice. This means that the total distance it has traveled

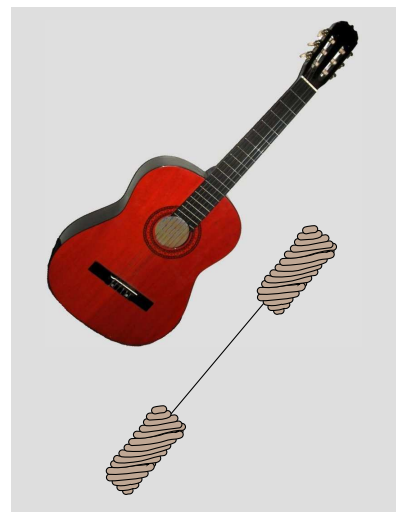

n / We model a guitar string attached to the guitar’s body at both ends as a light-weight string attached to extremely heavy strings at its ends.

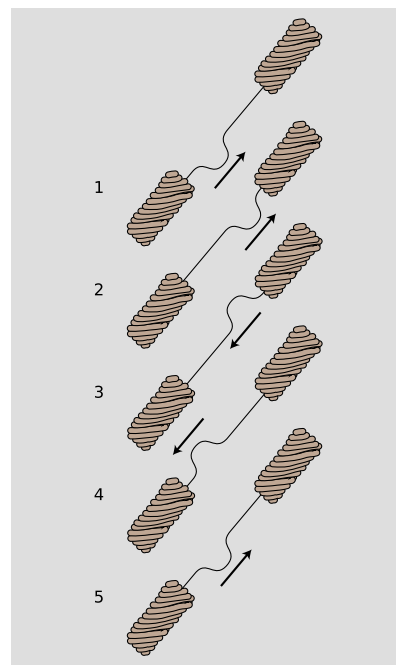

o / The motion of a pulse on the string.

equals  $2L$ , where  $L$  is the length of the string. Given this fact, what are the period and frequency of the sound it produces, expressed in terms of  $L$  and  $v$ , the velocity of the wave? ▷ Answer, p. 102

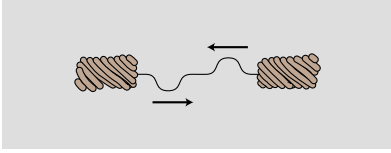

p / A tricky way to double the frequency.

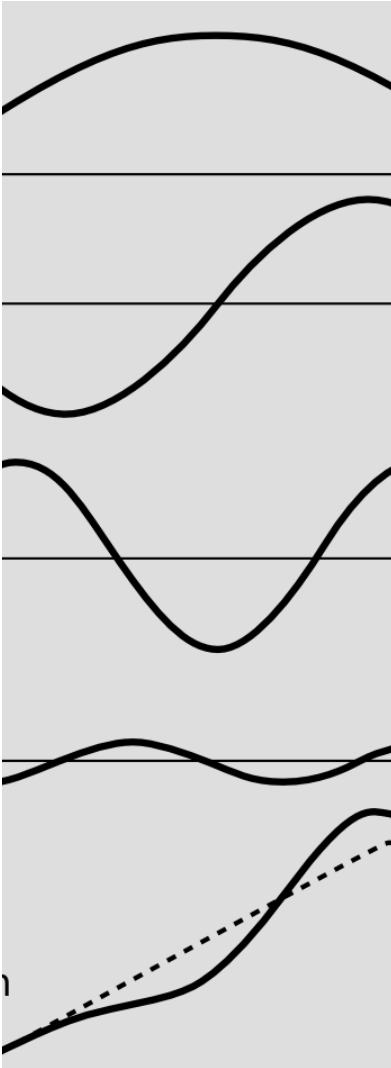

q / Using the sum of four sine waves to approximate the triangular initial shape of a plucked guitar string.

Note that if the waves on the string obey the principle of superposition, then the velocity must be independent of amplitude, and the guitar will produce the same pitch regardless of whether it is played loudly or softly. In reality, waves on a string obey the principle of superposition approximately, but not exactly. The guitar, like just about any acoustic instrument, is a little out of tune when played loudly. (The effect is more pronounced for wind instruments than for strings, but wind players are able to compensate for it.)

Now there is only one hole in our reasoning. Suppose we somehow arrange to have an initial setup consisting of two identical pulses heading toward each other, as in figure p. They will pass through each other, undergo a single inverting reflection, and come back to a configuration in which their positions have been exactly interchanged. This means that the period of vibration is half as long. The frequency is twice as high.

This might seem like a purely academic possibility, since nobody actually plays the guitar with two picks at once! But in fact it is an example of a very general fact about waves that are bounded on both sides. A mathematical theorem called Fourier's theorem states that any wave can be created by superposing sine waves. Figure q shows how even by using only four sine waves with appropriately chosen amplitudes, we can arrive at a sum which is a decent approximation to the realistic triangular shape of a guitar string being plucked. The one-hump wave, in which half a wavelength fits on the string, will behave like the single pulse we originally discussed. We call its frequency  $f_o$ . The two-hump wave, with one whole wavelength, is very much like the two-pulse example. For the reasons discussed above, its frequency is  $2f_o$ . Similarly, the three-hump and four-hump waves have frequencies of  $3f_o$  and  $4f_o$ .

Theoretically we would need to add together infinitely many such wave patterns to describe the initial triangular shape of the string exactly, although the amplitudes required for the very high frequency parts would be very small, and an excellent approximation could be achieved with as few as ten waves.

We thus arrive at the following very general conclusion. Whenever a wave pattern exists in a medium bounded on both sides by media in which the wave speed is very different, the motion can be broken down into the motion of a (theoretically infinite) series of sine waves, with frequencies  $f_o, 2f_o, 3f_o, \dots$ . Except for some technical details, to be discussed below, this analysis applies to a vast range of sound-producing systems, including the air column within the human vocal tract. Because sounds composed of this kind of pattern of frequencies are so common, our ear-brain system has evolved so

as to perceive them as a single, fused sensation of tone.

### Musical applications

Many musicians claim to be able to pick out by ear several of the frequencies  $2f_o$ ,  $3f_o$ , ..., called overtones or *harmonics* of the fundamental  $f_o$ , but they are kidding themselves. In reality, the overtone series has two important roles in music, neither of which depends on this fictitious ability to “hear out” the individual overtones.

First, the relative strengths of the overtones is an important part of the personality of a sound, called its timbre (rhymes with “amber”). The characteristic tone of the brass instruments, for example, is a sound that starts out with a very strong harmonic series extending up to very high frequencies, but whose higher harmonics die down drastically as the attack changes to the sustained portion of the note.

Second, although the ear cannot separate the individual harmonics of a single musical tone, it is very sensitive to clashes between the overtones of notes played simultaneously, i.e., in harmony. We tend to perceive a combination of notes as being dissonant if they have overtones that are close but not the same. Roughly speaking, strong overtones whose frequencies differ by more than 1% and less than 10% cause the notes to sound dissonant. It is important to realize that the term “dissonance” is not a negative one in music. No matter how long you search the radio dial, you will never hear more than three seconds of music without at least one dissonant combination of notes. Dissonance is a necessary ingredient in the creation of a musical cycle of tension and release. Musically knowledgeable people don’t use the word “dissonant” as a criticism of music, although dissonance can be used in a clumsy way, or without providing any contrast between dissonance and consonance.

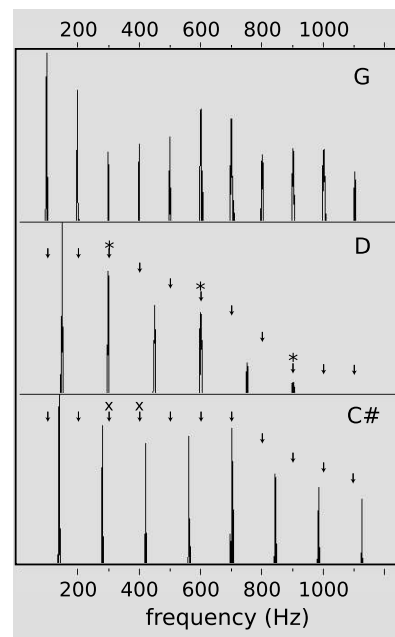

r / Graphs of loudness versus frequency for the vowel “ah,” sung as three different musical notes. G is consonant with D, since every overtone of G that is close to an overtone of D (\*) is at exactly the same frequency. G and C# are dissonant together, since some of the overtones of G (x) are close to, but not right on top of, those of C#.

s / Standing waves on a spring.

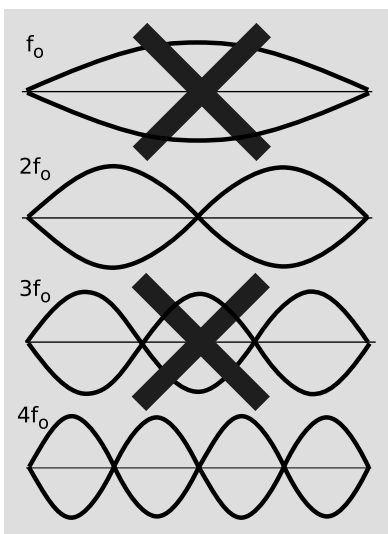
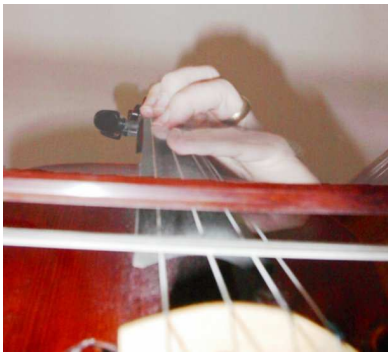
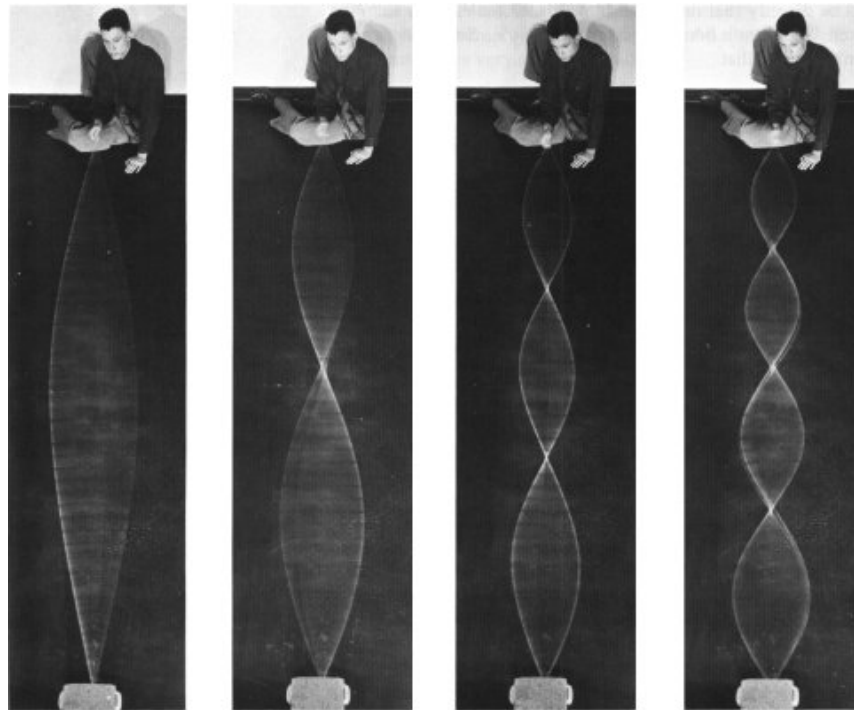

### Standing waves

Figure s shows sinusoidal wave patterns made by shaking a rope. I used to enjoy doing this at the bank with the pens on chains, back in the days when people actually went to the bank. You might think that I and the person in the photos had to practice for a long time in order to get such nice sine waves. In fact, a sine wave is the only shape that can create this kind of wave pattern, called a standing wave, which simply vibrates back and forth in one place without moving. The sine wave just creates itself automatically when you find the right frequency, because no other shape is possible.

#### *Harmonics on string instruments*

#### *example 7*

Figure t shows a violist playing what string players refer to as a natural harmonic. The term “harmonic” is used here in a somewhat different sense than in physics. The musician’s pinkie is pressing very lightly against the string — not hard enough to make it touch the fingerboard — at a point precisely at the center of the string’s length. As shown in the diagram, this allows the string to vibrate at frequencies  $2f_0$ ,  $4f_0$ ,  $6f_0$ , . . . , which have stationary points at the center of the string, but not at the odd multiples  $f_0$ ,  $3f_0$ , . . . . Since all the overtones are multiples of  $2f_0$ , the ear perceives  $2f_0$  as the basic frequency of the note. In musical terms, doubling the frequency corresponds to raising the pitch by an octave. The technique can be used in order to make it easier to play high notes in rapid passages, or for its own sake, because of the change in timbre.

t / Example 7.

If you think about it, it’s not even obvious that sine waves should

be able to do this trick. After all, waves are supposed to travel at a set speed, aren't they? The speed isn't supposed to be zero! Well, we can actually think of a standing wave as a superposition of a moving sine wave with its own reflection, which is moving the opposite way. Sine waves have the unique mathematical property that the sum of sine waves of equal wavelength is simply a new sine wave with the same wavelength. As the two sine waves go back and forth, they always cancel perfectly at the ends, and their sum appears to stand still.

Standing wave patterns are rather important, since atoms are really standing-wave patterns of electron waves. You are a standing wave!

### Standing-wave patterns of air columns

The air column inside a wind instrument or the human vocal tract behaves very much like the wave-on-a-string example we've been concentrating on so far, the main difference being that we may have either inverting or noninverting reflections at the ends.

#### *Inverting reflection at one end and noninverting at the other*

If you blow over the mouth of a beer bottle to produce a tone, the bottle outlines an air column that is closed at the bottom and open at the top. Sound waves will be reflected at the bottom because of the difference in the speed of sound in air and glass. The speed of sound is greater in glass (because its stiffness more than compensates for its higher density compared to air). Using the type of reasoning outlined in optional section 4.2, we find that this reflection will be density-noninverting: a compression comes back as a compression, and a rarefaction as a rarefaction. There will be strong reflection and very weak transmission, since the difference in speeds is so great. But why do we get a reflection at the *mouth* of the bottle? There is no change in medium there, and the air inside the bottle is connected to the air in the room. This is a type of reflection that has to do with the three-dimensional shape of the sound waves, and cannot be treated the same way as the other types of reflection we have encountered. Since this chapter is supposed to be confined mainly to wave motion in one dimension, and it would take us too far afield here to explain it in detail, but the reason has to do with readjustment of the wave pattern from a plane wave to a spherical wave. If the readjustment was as sudden as that shown in the figure, then there would be kinks in the wave. Waves don't like to develop kinks. In section 4.2 we deduced the strength of the reflected wave at a change in medium from the requirement that the wave would not have discontinuities or kinks. Here there is no change in medium, but a reflected wave is still required in order to avoid kinks.

The important point is that whereas the reflection at the bottom was density-noninverting, the one at the top is density-inverting. This means that at the top of the bottle, a compression superimposes

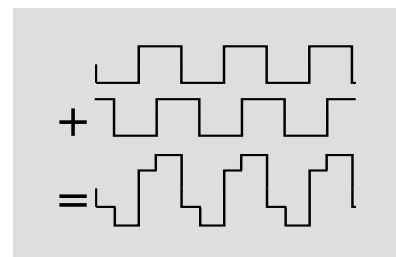
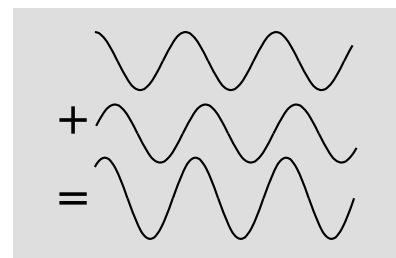

v / Sine waves add to make sine waves. Other functions don't have this property.



v / Surprisingly, sound waves undergo partial reflection at the open ends of tubes as well as closed ones.

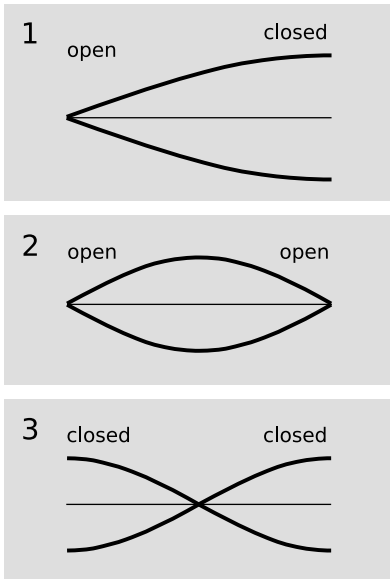

w / Graphs of excess density versus position for the lowest-frequency standing waves of three types of air columns. Points on the axis have normal air density.

with its own reflection, which is a rarefaction. The two nearly cancel, and so the wave has almost zero amplitude at the mouth of the bottle. The opposite is true at the bottom — here we have a peak in the standing-wave pattern, not a stationary point. The standing wave with the lowest frequency, i.e., the longest wave length, is therefore one in which  $1/4$  of a wavelength fits along the length of the tube, as shown in figure w/1.

*Both ends the same*

If both ends are open (as in the flute) or both ends closed (as in some organ pipes), then the standing wave pattern must be symmetric. The lowest-frequency wave fits half a wavelength in the tube, w/2-3.

*self-check F*

Draw a graph of pressure versus position for the first overtone of the air column in a tube open at one end and closed at the other. This will be the next-to-longest possible wavelength that allows for a point of maximum vibration at one end and a point of no vibration at the other. How many times shorter will its wavelength be compared to the frequency of the lowest-frequency standing wave, shown in the figure? Based on this, how many times greater will its frequency be?   ▷ Answer, p. 102

## Summary

### Selected Vocabulary

reflection . . . . .	the bouncing back of part of a wave from a boundary
transmission . . . .	the continuation of part of a wave through a boundary
absorption . . . . .	the gradual conversion of wave energy into heating of the medium
standing wave . . . .	a wave pattern that stays in one place

### Notation

$\lambda$ . . . . .	wavelength (Greek letter lambda)
---------------------	----------------------------------

### Summary

Whenever a wave encounters the boundary between two media in which its speeds are different, part of the wave is reflected and part is transmitted. The reflection is always reversed front-to-back, but may also be inverted in amplitude. Whether the reflection is inverted depends on how the wave speeds in the two media compare, e.g., a wave on a string is uninverted when it is reflected back into a segment of string where its speed is lower. The greater the difference in wave speed between the two media, the greater the fraction of the wave energy that is reflected. Surprisingly, a wave in a dense material like wood will be strongly reflected back into the wood at a wood-air boundary.

A one-dimensional wave confined by highly reflective boundaries on two sides will display motion which is periodic. For example, if both reflections are inverting, the wave will have a period equal to twice the time required to traverse the region, or to that time divided by an integer. An important special case is a sinusoidal wave; in this case, the wave forms a stationary pattern composed of a superposition of sine waves moving in opposite direction.

## Problems

### Key

- ✓ A computerized answer check is available online.
- ∫ A problem that requires calculus.
- ★ A difficult problem.

**1** Light travels faster in warmer air. Use this fact to explain the formation of a mirage appearing like the shiny surface of a pool of water when there is a layer of hot air above a road. (For simplicity, pretend that there is actually a sharp boundary between the hot layer and the cooler layer above it.)

**2** (a) Using the equations from optional section 4.2, compute the amplitude of light that is reflected back into air at an air-water interface, relative to the amplitude of the incident wave. The speeds of light in air and water are  $3.0 \times 10^8$  and  $2.2 \times 10^8$  m/s, respectively.

(b) Find the energy of the reflected wave as a fraction of the incident energy. [Hint: The answers to the two parts are not the same.]

✓

**3** A B-flat clarinet (the most common kind) produces its lowest note, at about 230 Hz, when half of a wavelength fits inside its tube. Compute the length of the clarinet. [Check: The actual length of a clarinet is about 67 cm from the tip of the mouthpiece to the end of the bell. Because the behavior of the clarinet and its coupling to air outside it is a little more complex than that of a simple tube enclosing a cylindrical air column, your answer will be close to this value, but not exactly equal to it.]

**4** (a) A good tenor saxophone player can play all of the following notes without changing her fingering, simply by altering the tightness of her lips: E $\flat$  (150 Hz), E $\flat$  (300 Hz), B $\flat$  (450 Hz), and E $\flat$  (600 Hz). How is this possible? (b) Some saxophone players are known for their ability to use this technique to play “freak notes,” i.e., notes above the normal range of the instrument. Why isn’t it possible to play notes below the normal range using this technique?

- C 261.6 Hz
- D 293.7
- E 329.6
- F 349.2
- G 392.0
- A 440.0
- B $\flat$  466.2

**5** The table gives the frequencies of the notes that make up the key of F major, starting from middle C and going up through all seven notes. (a) Calculate the first five or six harmonics of C and G, and determine whether these two notes will be consonant or dissonant. (b) Do the same for C and B $\flat$ . [Hint: Remember that harmonics that differ by about 1-10% cause dissonance.]

**6** Brass and wind instruments go up in pitch as the musician warms up. Suppose a particular trumpet’s frequency goes up by 1.2%. Let’s consider possible physical reasons for the change in pitch. (a) Solids generally expand with increasing temperature, because the stronger random motion of the atoms tends to bump them apart. Brass expands by  $1.88 \times 10^{-5}$  per degree C. Would this tend

Problem 5.



to raise the pitch, or lower it? Estimate the size of the effect in comparison with the observed change in frequency. (b) The speed of sound in a gas is proportional to the square root of the absolute temperature, where zero absolute temperature is  $-273$  degrees C. As in part a, analyze the size and direction of the effect. (c) Determine the change in temperature, in units of degrees C, that would account for the observed effect.

**7** Your exhaled breath contains about 4.5% carbon dioxide, and is therefore more dense than fresh air by about 2.3%. By analogy with the treatment of waves on a string in section 3.2, we expect that the speed of sound will be inversely proportional to the square root of the density of the gas. Calculate the effect on the frequency produced by a wind instrument.

# Appendix 1: Exercises

## Exercise 1A: Vibrations

Equipment:

- air track and carts of two different masses
- springs
- spring scales

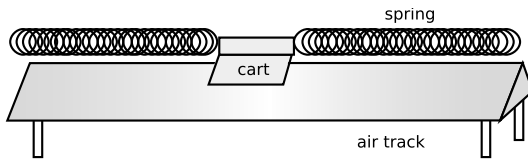

Place the cart on the air track and attach springs so that it can vibrate.

1. Test whether the period of vibration depends on amplitude. Try at least two moderate amplitudes, for which the springs do not go slack, and at least one amplitude that is large enough so that they do go slack.
2. Try a cart with a different mass. Does the period change by the expected factor, based on the equation  $T = 2\pi\sqrt{m/k}$ ?
3. Use a spring scale to pull the cart away from equilibrium, and make a graph of force versus position. Is it linear? If so, what is its slope?
4. Test the equation  $T = 2\pi\sqrt{m/k}$  numerically.

## Exercise 2A: Worksheet on Resonance

1. Compare the oscillator's energies at A, B, C, and D.

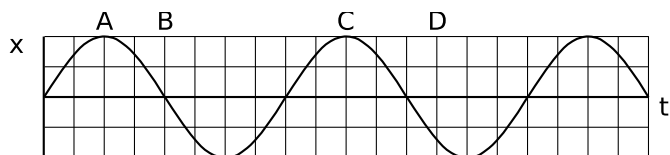

2. Compare the  $Q$  values of the two oscillators.

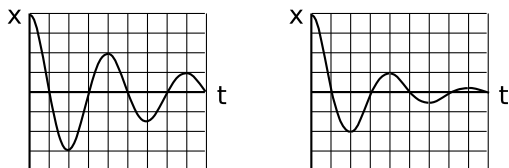

3. Match the  $x$ - $t$  graphs in #2 with the amplitude-frequency graphs below.

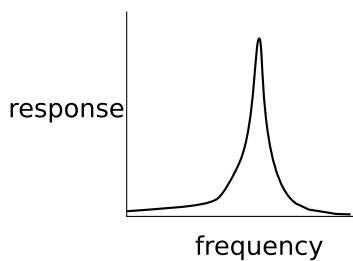
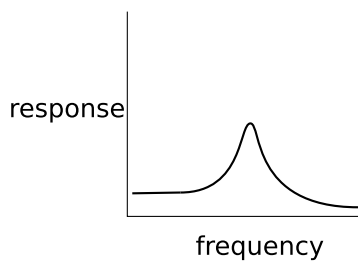

# Appendix 2: Photo Credits

Except as specifically noted below or in a parenthetical credit in the caption of a figure, all the illustrations in this book are under my own copyright, and are copyleft licensed under the same license as the rest of the book.

In some cases it's clear from the date that the figure is public domain, but I don't know the name of the artist or photographer; I would be grateful to anyone who could help me to give proper credit. I have assumed that images that come from U.S. government web pages are copyright-free, since products of federal agencies fall into the public domain. I've included some public-domain paintings; photographic reproductions of them are not copyrightable in the U.S. (*Bridgeman Art Library, Ltd. v. Corel Corp.*, 36 F. Supp. 2d 191, S.D.N.Y. 1999).

When "PSSC Physics" is given as a credit, it indicates that the figure is from the first edition of the textbook entitled *Physics*, by the Physical Science Study Committee. The early editions of these books never had their copyrights renewed, and are now therefore in the public domain. There is also a blanket permission given in the later PSSC College Physics edition, which states on the copyright page that "The materials taken from the original and second editions and the Advanced Topics of PSSC PHYSICS included in this text will be available to all publishers for use in English after December 31, 1970, and in translations after December 31, 1975."

Credits to Millikan and Gale refer to the textbooks *Practical Physics* (1920) and *Elements of Physics* (1927). Both are public domain. (The 1927 version did not have its copyright renewed.) Since it is possible that some of the illustrations in the 1927 version had their copyrights renewed and are still under copyright, I have only used them when it was clear that they were originally taken from public domain sources.

In a few cases, I have made use of images under the fair use doctrine. However, I am not a lawyer, and the laws on fair use are vague, so you should not assume that it's legal for you to use these images. In particular, fair use law may give you less leeway than it gives me, because I'm using the images for educational purposes, and giving the book away for free. Likewise, if the photo credit says "courtesy of ...," that means the copyright owner gave me permission to use it, but that doesn't mean you have permission to use it.

**Contents** *Bridge, MRI, surfer, x-ray, galaxy*: see below. **21** *Jupiter*: Uncopyrighted image from the Voyager probe. Line art by the author. **25** *Tacoma Narrows Bridge*: Public domain, from Stillman Fires Collection: Tacoma Fire Dept, [www.archive.org](http://www.archive.org). **33** *Nimitz Freeway*: Unknown photographer, courtesy of the UC Berkeley Earth Sciences and Map Library. **37** *Two-dimensional MRI*: Image of the author's wife. **37** *Three-dimensional brain*: R. Malladi, LBNL. **44** *Spider oscillations*: Emile, Le Floch, and Vollrath, *Nature* 440:621 (2006). **??** *Painting of waves*: Katsushika Hokusai (1760-1849), public domain. **50** *Superposition of pulses*: Photo from PSSC Physics. **51** *Marker on spring as pulse passes by*: PSSC Physics. **52** *Surfing (hand drag)*: Stan Shebs, GFDL licensed (Wikimedia Commons). **62** *Fetus*: Image of the author's daughter. **52** *Breaking wave*: Ole Kils, olekils at web.de, GFDL licensed (Wikipedia). **61** *Wavelengths of circular and linear waves*: PSSC Physics. **62** *Changing wavelength*: PSSC Physics. **65** *Doppler effect for water waves*: PSSC Physics. **66** *Doppler radar*: Public domain image by NOAA, an agency of the U.S. federal government. **67** *M51 galaxy*: public domain Hubble Space Telescope image, courtesy of NASA, ESA, S. Beckwith (STScI), and The Hubble Heritage Team (STScI/AURA). **68** *Mount Wilson*: Andrew Dunn, cc-by-sa licensed. **69** *X15*: NASA, public domain. **69** *Jet breaking the sound barrier*: Public domain product of the U.S. government, U.S. Navy photo by Ensign John Gay. **75** *Human cross-section*: Courtesy of the Visible Human Project, National Library of Medicine, US NIH. **77** *Reflection of circular waves*: PSSC Physics. **77** *Reflection of pulses*: PSSC Physics. **78** *Reflection of pulses*: Photo from PSSC Physics. **80** *X-ray image of hand*: 1896 image produced by Roentgen. **89** *Photo of guitar*: Wikimedia Commons, dedicated to the public domain by user TscA. **92** *Standing waves*: PSSC Physics.